

**XPEED**®  
*CRAFTED FOR CHAMPION*

**CATALOGUE**  
**2026-27**

**BOXING | MMA | KARATE | JIU JITSU | TAEKWONDO | FITNESS**

    /xpeed1980

# Approved Partnerships

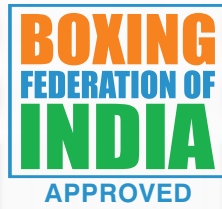

UNIT-1



UNIT-2





## COMPANY PROFILE

Xpeed is a proudly owned and operated Indian Contact sports and fitness brand with a vision to cater for all involved in the any type of contact sports equipment ( Boxing , MMA , karate, taekwondo, Kick boxing Muay Thai and Brazilian jiu-jitsu) and health/ fitness industry. ...

"Our Parent company Krishna sports industries has been well established since 1956 with 3rd Generation in business .. Krishna sports industries is the largest manufacturer of Boxing and combat equipment ..The Company is OEM for many international brands and retailers around the world.. By capitalizing the wealth of experience and technical wisdom, the company has developed the Own brand under the name of Xpeed in India ...

"We have in-house workforce of more than 500 workers , we have dedicated craftsmen who have been specialist in manufacturing soft leather goods (Boxing , MMA , karate, taekwondo, Kick boxing, Muay Thai Brazilian jiu-jitsu) for more than 25years.

Our team at Xpeed has countless years of experience in all aspects of the industry and we are driven to provide the highest quality equipment at most affordable prices. Not only we are driven to provide high quality products for our athletes, we have strong focus on providing before and after sales support through our dedicated service team.. Our reputation has been built on value, quality , Innovation and service but we never stop striving to even better. We are constantly engaging with our many customers to help research , improve and develop new Products .. This catalogue is the result of listening to our customers.

Durgesh Wadhwa

Owner

PS if you would like to contact me directly for any reason , don't hesitate ..

I will make sure you are looked after! [dury@krishnasports.com](mailto:dury@krishnasports.com) ( Mobile – 9814066650)

Ethical sourcing

Xpeed is committed to ethical manufacturing and sourcing with highest standards .. We work very closely with our International supplier for fitness/ gym equipment to ensure all business is conducted in accordance with International obligations..

We are **ISO 9001** and **SA 8001** certified company.



# CONTENTS

	Pages
Packaging & colour box	01
Invader IV series	02-06
Fighter series	07-11
Elite series	12-15
XPD Tech Series	16-22
Elite Ex series	23-25
Revolution RT series	26-29
Impact GX-3 series	30-33
Accessories	34
MMA Gear Range	35-37
Training Dummies	38-40
Strength & Training	41
Coaching & training Rage	42-44
Punch bag	45-52
Free standing bag	53-57
Wrestling Ring & Arena	58-59
Judo Sports Mats	60-61
Wushu Sanda	62
MMA Cage	63
Boxing Ring & Accessories	64-68
Karate Range	69-72
Karate & Taekwondo Suit	73-74
Judo Suit	75
Training Range	76
Taekwondo Range	77-79
Kick Boxing Range	80-81
Wushu Range	82-83
Performance Clothing	84-93
Fitness Clothing	94-98
Skipping Rope	99-100
Plyo Boxes	101-102
Fitness Range	103-108
Weightlifting Belt	109-111
Med & Function Ball	112-115
Aerobic Step & Fitness	116-122
Strength & Kettle Bell	123-127
Dumbbells	128-130
Mat Range	131-133
Fitness Gloves	134-137
Strength & free Weight	138-155
Assault Fitness Range	156
Gym & Travel Bags	157-159
Cricket Wickets & Accessories	160-163
Dart board Games	164
Foosball soccer Table	165
Air Ice Hockey table	166
Folding Table Tennis	167
Camping Tent, Bed & Chair	168-170
Size Chart	171-175



# PACKAGING & COLOR BOX

Our packaging design is both innovative and eco-friendly, crafted by our dedicated design team. We prioritize sustainability while ensuring that our packaging effectively communicates the unique features of our products. Each design is thoughtfully created to enhance the customer experience, reflecting our commitment to quality and environmental responsibility.





XXX

30

15



**CODE XP100**  
**LACEUP GLOVE**

- Crafted from genuine leather.
- Provides maximum wrist support.
- Customized fit and lace up closure.
- Designed for optimal performance.
- Precision stitching for a tailored fit.

**INJECTION**  
**MOULD FOAM**

per pair

Code	Size	Color	MRP.
XP100	8,10,12,14,16oz	Black/White Red/White Blue/White	4100.00



**CODE XP101**  
**CONTEST BOXING GLOVE**

- Made out of High quality Leather.
- Injection Mould Foam Padding.
- Precision stitching for a tailored fit.



**INJECTION MOULD FOAM**

Code	Size	Color	per pair MRP.
XP101	8,10,12,14,16oz	Red/White Blue/White	3400.00

**CODE XP102**  
**TRAINING BOXING GLOVE**

- Made out of High quality PU.
- Injection Mould Foam Padding.
- Precision stitching for a tailored fit.

**INJECTION MOULD FOAM**

Code	Size	Color	per pair MRP.
XP102	8,10,12,14,16oz	Red/White Blue/White	2100.00



**CODE XP109**  
**CONTEST ABDGUARD**

- Made out of High quality leather
- Extra Comfort & protection
- Anatomic shape for best fitting
- Adjustable strap ensure a customizable & snug fit
- Constructed with precision stitching

**LAYERED FOAM PADDING**

Code	Size	Color	per pc MRP.
XP109	S,M,L,XL	Red/Blue	2300.00



**CODE XP103**  
**CONTEST HEADGUARD**

- Made out of High quality Leather.
- Multi-layer padding for superior protection.
- Adjustable straps for personalized comfort.

**3** LAYERED PADDING SYS.

Code	Size	Color	MRP.
XP103	S/M, L/XL	Red/White Blue/White	3200.00



**CODE XP104**  
**TRAINING HEADGUARD**

- Made out of High quality PU.
- Multi-layer padding for superior protection.
- Adjustable straps for personalized comfort.

**3** LAYERED PADDING SYS.

Code	Size	Color	MRP.
XP104	S/M, L/XL	Red/White Blue/White	1850.00



**CODE XP 2474**  
**BOON PAD LEATHER**

- Made of high quality cowhide leather
- Easy and flexible to use
- Light weight impact absorbing padding.
- Compact size.

**LAYERED**  
FOAM PADDING

Code	Size	Color	MRP.
XP2474	STD	Black/White	2800.00



**CODE XP106**  
**LOW-TOP MESH/SUADE**

- Breathable air vents on all sides combined with a shock absorbing eva mid-sole ensures comfort throughout even the most rigorous training sessions.
- Rubber sole with anti-slip pattern allow for sharp cuts and strong footholds enhancing any boxer's ring abilities.

Code	Size	Color	MRP.
XP106	8,9,10,11,12	Red/White Blue/White Black/White	2400.00



**CODE XP107**  
**ELASTIC/ NYLON HANDWRAP**

- Nylon material ensures durability
- Lightweight and breathable
- Elasticated and secure fit
- Protects your hands and wrists from potential injuries and sprains.
- Available in various colours to suit personal preferences

Code	Size	Color	MRP.
XP107	108, 180 inch	Black, Red, White, Pink Blue	210.00 (108") 250.00 (180")



**CODE XP108**  
**NYLON HANDWRAP PRINTED 4 MTR.**

- Durable nylon material
- Printed nylon hand wraps offer style and substance in one
- Provides essential wrist and knuckle support
- Easy to clean, maintain, and retain their vibrant print over time

Code	Size	Color	MRP.
XP108	2.5 Mtr. 4 Mtr.	Black/Red White/Black Blue/White Red/ Black	300.00 470.00





### **PREMIUM GRADE LEATHER**

Premium Grade buffalo Leather is the toughest and most supple leather available, which means premium support and comfort for these fighter gloves.



### **INJECTION MOULDED FOAM**

Injection moulded foam padding for shape retention and protection ultra smart design allows for minimum hand movement



### **ANTI MICRO LINING**

Anti microbial lining. The anti-microbial lining is designed to absorb any odour lingering in the glove. The glove also features a moisture wicking lining that is designed to withdraw moisture away from the skin when in use.

**ANTI-MICRO  
LINING** 

**WRIST  
SUPPORT** 

**IMF 2.0**  
ADVANCE FOAM TECH



**CODE XP2486**  
**FIGHTER BOXING GLOVES**

- Premium Grade buffalo Leather is the toughest and most supple leather available, which means premium support and comfort for these fighter gloves.
- Injection moulded foam padding for shape retention and protection ultra smart design allows for minimum hand movement
- Anti microbial lining. The anti-microbial lining is designed to absorb any odour lingering in the glove. The glove also features a moisture wicking lining that is designed to draw moisture away from the skin when in use.

ANTI-MICRO LINING WRIST SUPPORT IMF 2.0 ADVANCE FOAM TECH per pair

Code	Size	Color	MRP.
XP2486	10,12,14,160Z	Red/Black	4200.00



**CODE XP2487**  
**FIGHTER FOCUS PAD**

**Premium Quality Goat Leather**

The toughest and most supple leather available. The buffalo nappa leather is designed to match your determination and strength.

**Support Wedge**

Raised foam wedge to support correct hand positioning and protect from any wrist impact.

**Impact Zone**

Gel infused impact zone in the center of the focus pad provides an extra layer of cushioning from high impact blows.

**Impact Ball**

Internal cushioned ball to encourage better hand stability and reduce stress on joints from impact.

**3** LAYERED PADDING SYS. per pair

Code	Size	Color	MRP.
XP2487	STD.	Red/Black	4200.00



**CODE XP2488**  
**FIGHTER BOON PAD**

**Premium Quality Goat Leather**

The toughest and most supple leather available. The Goat Skin leather is designed to match your determination and strength.

**Compact Design**

A lightweight and compact design Speed pad will encourage faster and more accurate pad work.

**Impact Zone**

Gel infused impact zone in the center of the focus pad provides an extra layer of cushioning from high impact blows.

**Impact Ball**

Internal cushioned ball to encourage better hand stability and reduce stress on joints from impact.

**3** LAYERED PADDING SYS. per pair

Code	Size	Color	MRP.
XP2488	STD.	Red/Black	3200.00



**CODE XP2489**  
**FIGHTER THAI PAD (1 pair)**

- Durable PU construction.
- Very light and compact design.
- Stable, durable foam padding.
- Slightly curved for a better hitting area.
- 1 sturdy handle and 2 forearm straps.
- Perfect for punches, kicks, knees and elbow strikes.



per pair

Code	Size	Color	MRP.
XP2489	18.5x9x2.5 INCH	Red/Black	5400.00- PU 6600.00 Leather



**CODE XP2490**  
**FIGHTER ROUND PAD (LARGE DIAMETER)**

- High quality heavy PU construction.
- The Round Pad is a core training aid when practicing correct body blows, with two generously padded leather grab handles it allows for a greater use of flexibility within a workout session as a multitude of strikes from all angles can be negated with the correct positioning of the shield allowing the opponent to practice all types of punches, elbow and leg strikes to the body and thigh areas.
- Triple layered foam for superior shock absorption.



per pc

Code	Size	Color	MRP.
XP2490	16x6.25 INCH	Red/Black	2850.00



**CODE XP2491**  
**FIGHTER STRIKE SHIELD (per pc)**

- Durable Matt PU construction.
- Curved design for a perfect striking surface.
- Triple density foam for an ultimate shock absorption.
- Multiple handles for intensive and varied training.
- Reinforced stitching for enhanced durability.



per pc

Code	Size	Color	MRP.
XP2491	23x15x4 INCH	Red/Black	2950.00



**CODE XP2492**  
**FIGHTER WALL MOUNT**

The ideal training bag for home or gym use, especially when space is a concern or to take advantage of extra wall space.

Throw every offensive weapon in your arsenal with jabs, hooks, uppercuts, straight shots, elbow strikes, kicks, knees and much, much more.

Professionally contoured full grain Synthetic leather bag is triple stitched at the seams and comes complete with raised target zones for top level training.



per pc

Code	Size	Color	MRP.
XP2492	22.5x15x18 INCH	Red/Black	9000.00 PU 14900.00 Leather

**CODE XP2493**  
**FIGHTER FAN PAD**

Kicking pads improve your striking built to last leather material grip with elastic attached to keep coach's grip easy to clean material



per pair

Code	Size	Color	MRP.
XP2493	14x7x1 INCH	Red/Black	2500.00



**CODE XP2494**  
**FIGHTER BOXING STICK**

- Xpeed training sticks are a totally new and innovative training tool to help propel your game to the highest level.
- Develop pin-point precision and accuracy with all punches and combinations for every skill level.
- The training sticks are professionally padded targets that trainers incorporate into workouts in replacement of punch mitts.
- Internal PVC tube keeps the Training Sticks tall and strong, while a durable Cordura nylon cover is built to last.



per pair

Code	Size	Color	MRP.
XP2494	19x2dia inch 6 circumference	Red/Black	2300.00



**CODE XP2496**  
**FIGHTER HEADGUARD**

- Premium Grade buffalo Leather is the toughest and most supple leather available
- Layered foam padding for shape retention and protection
- Anti microbial lining. The anti-microbial lining is designed to absorb any odour lingering in the Headguard.
- The headguard also features a moisture wicking lining that is designed to draw moisture away from the skin when in use.



per pc

Code	Size	Color	MRP.
XP2496	S/M, L/XL	Red/Black	3800.00



**CODE XP2495**  
**FIGHTER STANDING BAG**

The Free-Standing Fitness Punching Bag is always ready for a solid strength building aerobic fitness workout.

Non-hanging heavy bag design allows you to exercise wherever is most convenient - perfect for your home or commercial gym.

The shock-absorbing foam is encased in a durable vinyl shell and includes an added base pad for protection when kicking.

Unlike other free-standing bags this heavy bag can take a hit without falling over - Punch your way to a fit and healthy lifestyle with this solid heavy bag.



per pc

Code	Size	Color	MRP.
XP2495	80x18x23 INCH	Red/Black	31200.00





**4** LAYERED  
PADDING SYS.

 **SOFT**  
LINING



**CODE XP2801**  
**ELITE CONTENDER BOXING GLOVE**

- Durable Leather/PU Construction.
- 4 Layer multi layer foam padding progressive protection for all level.
- Ever cool mesh palm helps keep you cool during the toughest workouts.
- Comfortable Soft Touch Lining.
- Tight secure fit with full wrist wrap hook & loop closure.
- Compression foam cuff system for idol protection on wrist while sparring.



per pair

Code	Size	Color	Material	MRP.
XP2801	10,12,14,16oz	White/Black	PU	2200.00
			Leather/PU	3600.00



**CODE XP2802**  
**SPARRING BOXING GLOVE**

- Ultimate Training Gloves
- Long Lasting Real Leather/PU Outer Shell
- Innovative Fit for More Comfort & Ultimate Wrist Protection
- Multi Compression / Density Foam Construction
- Great for Fitness Classes.

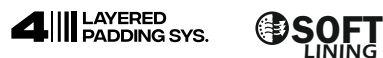

per pair

Code	Size	Color	Material	MRP.
XP2802	10,12,14,16oz	White/Black	PU	2300.00
			Leather/PU	3600.00



**CODE XP2804**  
**ELITE PROFESSIONAL BOXING GLOVE**

- Durable Leather/PU Construction
- Injection Mould Foam Padding
- Wide velcro wrap round wrist for great fit and wrist protection
- Comfortable soft touch lining.



per pair

Code	Size	Color	Material	MRP.
XP2804	10,12,14,16oz	White/Black	PU	2000.00
			Leather/PU	3250.00



**CODE XP2805**  
**ELITE PROFESSIONAL BOXING GLOVE**

- Durable Leather/PU Construction
- Injection Mould Foam Padding
- Wide velcro wrap round wrist for great fit and wrist protection
- Comfortable soft touch lining.



				per pair
Code	Size	Color	Material	MRP.
XP2805	10,12,14,16oz	Black/White	PU Leather/PU	2400.00 3600.00



**CODE XP2806**  
**ELITE FIGHTER AIR PAD**

- Engineered for Mitt Work
- Reverent classic design with modern performance
- Full leather construction
- AirCore technology helps dissipate impact energy for increased protection
- Multiple layered and density foam padding



				per pair
Code	Size	Color	Material	MRP.
XP2806	STD	Black/White	PU Leather/PU	2200.00 3800.00



**CODE XP2807**  
**ELITE MMA GLOVE**

- High quality Leather/PU construction with padded knuckle for shock absorption and protection
- Contoured padding protection with padded thumb
- Compression foam cuff system for idol protection on wrist while sparring
- Full wrist strap provides superior wrist support
- Comfortable Soft Touch Lining



				per pair
Code	Size	Color	Material	MRP.
XP2807	S/M, L/XL	Black/White	PU Leather/PU	1600.00 2650.00



**CODE XP2808**  
**ELITE MMA GLOVE WITHOUT THUMB**

- High quality Leather/PU construction with padded knuckle for shock absorption and protection
- Layered foam padding
- Full wrist strap provides superior wrist support
- Comfortable Soft Touch Lining

**INJECTION**  
**MOULD FOAM**

**SOFT**  
**LINING**

per pair

Code	Size	Color	Material	MRP.
XP2808	S/M, L/XL	Black/White	PU Leather/PU	1500.00 2400.00





- DURABLE MATT PU
- INJECTION MOULD FOAM
- SOFT TOUCH LINING.



**CODE XP3051**  
**MATT PU BOXING GLOVE**

- Durable Matt PU construction
- Injection Mould Foam Padding
- Boxing glove With full velcro Strap.
- Comfortable soft touch lining.



per pair

Code	Size	Color	MRP.
XP3051	4,6,8 oz	Black Matt	2000.00
	10, 12, 14, 16oz		2400.00



**CODE XP3052**  
**MATT PU BOXING GLOVE**

- Durable Matt PU construction
- Injection Mould Foam Padding
- Boxing glove With full velcro Strap.
- Comfortable soft touch lining.



per pair

Code	Size	Color	MRP.
XP3052	8,10oz (S/M)	Black Matt	2100.00
	12, 14oz (L/XL)		



**CODE XP3053**  
**MATT PU FOCUS PAD**

- Durable Matt PU construction
- Injection Mould Foam Padding
- Contoured shape punch mitt with wrist padding
- Formed palm 'ball' for comfort and control





per pair

Code	Size	Color	MRP.
XP3053	STD.	Black Matt	2400.00



**CODE XP3054**  
**MATT PU MMA GLOVE CUT FINGER**

- High quality PU construction with padded knuckle for shock absorption and protection.
- Ideal glove for mixed boxing fitness training.
- Hook and loop strap for easy on and off.
- Contoured padding protection with padded thumb.

  			per pair
Code	Size	Color	MRP.
XP3054	S/M, L/XL	Black Matt	1650.00



**CODE XP3055**  
**MATT PU STRIKING MMA GLOVE**



- Ideal glove for Mixed boxing fitness.
- High quality Matt PU construction.
- Injection Mould Foam Padding.
- Full wrist strap provides superior wrist support.
- Comfortable Soft Touch Lining.

  			per pair
Code	Size	Color	MRP.
XP3055	S/M, L/XL	Black Matt	1900.00



**CODE XP3056**  
**MATT PU SPARRING MMA GLOVE**

- Ideal glove for Mixed boxing fitness.
- High quality Matt PU construction.
- Injection Mould Foam Padding.
- Full wrist strap provides superior wrist support.
- Comfortable Soft Touch Lining.

  			per pair
Code	Size	Color	MRP.
XP3056	S/M, L/XL	Black Matt	1900.00



**CODE XP3057**  
**MATT PU HEADGUARD**

- Durable Matt PU construction.
- High-tech foam padding.
- Open face.
- Pleasant inner material.
- Velcro closure at back .



per pc

Code	Size	Color	MRP.
XP3057	S/M, L/XL	Black Matt	2500.00



**CODE XP3058**  
**MATT PU GRAPPLING SHINGUARD**

- Durable Matt PU construction.
- Shin guards for martial arts training.
- Medium-thick padding of the kick surface.
- 2 Velcro fasteners and an elastic band ensure a perfect hold.
- Additional padding of the forefoot.



per pair

Code	Size	Color	MRP.
XP3058	S/M, L/XL	Black Matt	2000.00



**CODE XP3059**  
**MATT PU STAND UP SHINGUARD**

- Durable Matt PU construction.
- Shin guards for martial arts training.
- Injection mould foam padding .
- 2 Velcro fasteners and an elastic band ensure a perfect hold.
- Additional padding of the forefoot.



per pair

Code	Size	Color	MRP.
XP3059	S,M,L,XL	Black Matt	3000.00



**CODE XP3060**  
**MATT PU SHINPAD WITH FOOT**

- Durable Matt PU construction.
- Shin guards for martial arts training.
- Injection mould foam padding including foot.
- 2 Velcro fasteners and an elastic band ensure a perfect hold.



per pair			
Code	Size	Color	MRP.
XP3060	S,M,L,XL	Black Matt	3100.00



**CODE XP3061**  
**TARGET PAD PER PAIR**

- High-quality microfiber outer material.
- EVA foam on the inside offer high durability and low weight.
- Due to the special paddle shape, all types of strokes and movements can be efficiently trained.
- This pads are suitable for boxing, MMA and kickboxing.



per pair			
Code	Size	Color	MRP.
XP3061	S/M, L/XL	Black Matt	2100.00



**CODE XP3062**  
**TARGET PAD PER PC**

- Durable Matt PU construction.
- Very light and compact design.
- Stable, durable foam padding.
- Slightly curved for a better hitting area.
- 1 sturdy handle and 2 forearm straps.
- Perfect for punches, kicks, knees and elbow strikes.



per pc			
Code	Size	Color	MRP.
XP3062	18.5x9x2.5 inch	Black Matt	3250.00



**CODE XP3063**  
**MATT PU SQUARE PAD**

- High quality heavy PU construction.
- Multi-layered, Foam padding absorbs the heaviest kicks, knees, and strikes during training.
- Easy to maneuver for multiple target options.
- Features reinforced rivets & padded handles to withstand impact and sustain a secure grip.



per pc

Code	Size	Color	MRP.
XP3063	15.75x15.75x6.25	Black Matt	3100.00



**CODE XP3064**  
**MATT PU ROUND PAD SMALL DIA**

- High quality heavy PU construction.
- The Round Pad is a core training aid when practicing correct body blows, with two generously padded leather grab handles it allows for a greater use of flexibility within a workout session as a multitude of strikes from all angles can be negated with the correct positioning of the shield allowing the opponent to practice all types of punches, elbow and leg strikes to the body and thigh areas.
- Triple layered foam for superior shock absorption.



per pc

Code	Size in inch	Color	MRP.
XP3064	12.25" diameter x 5.5 thick	Black Matt	2500.00



**CODE XP3065**  
**MATT PU STRIKE SHIELD**

- Durable Matt PU construction.
- Curved design for a perfect striking surface.
- Triple density foam for an ultimate shock absorption.
- Multiple handles for intensive and varied training.
- Reinforced stitching for enhanced durability.



per pc

Code	Size	Color	MRP.
XP3065	23x15x4 inch	Black Matt	3600.00



**CODE XP3066**  
**FABRIC SHINGUARD**

- 100% polyester Material.
- Shin guards for martial arts training.
- Comfortable compression material designed to firmly hug the legs and feet
- Moisture-wicking properties keep you dry during intense workouts.

**2** LAYERED PADDING SYS. *SKIN fit* TECHNOLOGY

per pair

Code	Size	Color	MRP.
XP3066	XS, S, M, L, XL, XXL	Black Matt	1300.00



**CODE XP3067**  
**FABRIC ELBOW GUARD**

- 100% polyester Material.
- Made of high-density strengthen foam, good elasticity, breathable fabric keeps skin dry, and more comfort.
- Elbow guard pain relief for gym and physical activities

**2** LAYERED PADDING SYS. *SKIN fit* TECHNOLOGY

per pair

Code	Size	Color	MRP.
XP3067	S/M, L/XL	Black	600.00



**CODE XP3068**  
**FABRIC KNEE GUARD**

- 100% polyester Material.
- Made of high-density strengthen foam, good elasticity, breathable fabric keeps skin dry, and more comfort.
- An ideal knee protector for outdoor sports.

**2** LAYERED PADDING SYS. *SKIN fit* TECHNOLOGY

per pair

Code	Size	Color	MRP.
XP3068	S/M, L/XL	Black	600.00







**CODE XP401**  
**PMFT SPARRING GLOVES**

- Made out of high quality PU.
- High density injection moulded foam padding
- Non-slip lining
- Velcro or hook-and-loop closure for a secure and adjustable fit.

**IMF2.0**  
ADVANCE FOAM TECH

per pair

Code	Size	Color	MRP.
XP401	8,10,12,14,16oz	Black/Red Black/Orange Black/Green Black/Yellow	2300.00



**CODE XP402**  
**PERFORMER BAG GLOVES**

- Made out of high quality PU.
- Non-slip lining.
- Light padding
- Easy hook & loop strap closure

**LAYERED**  
FOAM PADDING

per pair

Code	Size	Color	MRP.
XP402	S/M, L/XL	Black/Red Black/Orange Black/Green Black/Yellow	1300.00



**CODE XP403**  
**SPARRING HEADGUARD**

- Made out of high quality PU.
- Built to last, it offers new, thicker padding around the ear and chinstrap for greater comfort.
- Tapered cheek protectors for better protection.

**LAYERED**  
FOAM PADDING

per pc

Code	Size	Color	MRP.
XP403	S/M, L/XL	Black/Red Black/Orange Black/Green Black/Yellow	2050.00



**CODE XP404**  
**CURVED FOCUS PADS**

- Made out of high quality PU.
- High density, multi-layered foam padding for shock absorption.
- Ventilated Back of palm, Foam lined soft lining



			per pair
Code	Size	Color	MRP.
XP404	STD	Black/Red	2050.00
		Black/Orange	
		Black/Green	
		Black/Yellow	

**CODE XP405**  
**ABDOGUARD**

- Made out of high quality PU.
- Extra long hip wings for extra comfort and protection
- Anatomic shape for best fitting with big cup
- Adjustable straps ensure a customizable and snug fit
- Constructed with precision stitching for enhanced strength and resilience



			per pc
Code	Size	Color	MRP.
XP405	S,M,L,XL	Black/Red	1150.00
		Black/Orange	
		Black/Green	
		Black/Yellow	

**CODE XP406**  
**F/C BALL**

- Made out of high quality PU.
- New narrow loop.
- Full length strap sewn into entire length of ball.
- Heavy duty latex bladder.



			per pc
Code	Size in cm	Color	MRP.
XP406	35cm 63 diameter	Black/Red	1900.00
		Black/Orange	
		Black/Green	
		Black/Yellow	

**CODE XP407**  
**SPEED BALL**

- Made out of high quality PU.
- Heavy duty latex bladder.
- Strong reinforced loop.
- Enhance agility, hand eye coordination and speed



			per pc
Code	Size in cm	Color	MRP.
XP407	27cm 58 diameter	Black/Red	1300.00
		Black/Orange	
		Black/Green	
		Black/Yellow	

# REVOLUTIONARY

**INJECTION  
MOULD FOAM**

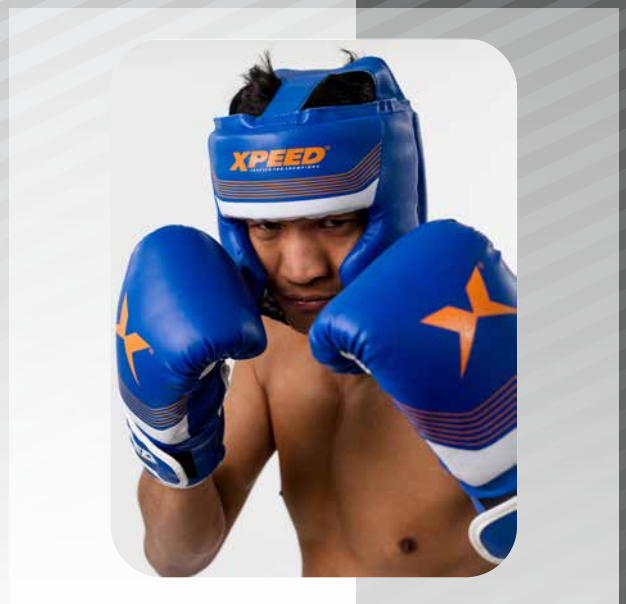



**CODE XP501**  
**SAFETY SPAR GLOVE**

- Made out of high quality PVC.
- High density foam padding for impact resistance
- Secure wrist closure for a snug fit.
- Reinforced stitching



per pair

Code	Size	Color	MRP.
XP501	8,10,12,14oz	Blue/white Red/white Black/white	1600.00



**CODE XP502**  
**BAG GLOVES**

- Made out of high quality PVC.
- High density foam padding for impact resistance
- Secure wrist closure for a snug fit.



per pair

Code	Size	Color	MRP.
XP502	STD	Blue/white Red/white Black/white	1100.00



**CODE XP105**  
**SPAR HEADGUARD**

- Made out of High quality PVC.
- Multi-layer padding for superior protection.
- Adjustable straps for personalized comfort.
- Contoured design for secure fit.



per pc

Code	Size	Color	MRP.
XP105	STD	Red/White Blue/White	1450.00



**CODE XP503**  
**STRAIGHT FOCUS PAD**

- Made out of high quality PVC.
- With added elasticated wrist support.
- Multi-layer foam for shock absorption.



per pair

Code	Size	Color	MRP.
XP503	STD	Blue/white Red/white Black/white	950.00



**CODE XP504**  
**CURVED FOCUS PADS**

- Made out of high quality PVC.
- Multi-layer foam padding .
- Formed palm 'ball' for comfort and control



per pair

Code	Size	Color	MRP.
XP504	STD	Blue/white Red/white Black/white	1300.00



**CODE XP506**  
**F/C BALL**

- Made out of high quality PVC.
- One size 9 inches floor to ceiling ball.
- Improve your punching accuracy and quickness.
- Extreme durability and performance



per pc

Code	Size in cm	Color	MRP.
XP506	40cm 72 diameter	Blue/white Red/white Black/white	1750.00



**CODE XP507**  
**SPEEDBALL**

- Made out of high quality PVC.
- Improves hand-eye coordination, speed, and agility
- Compact, easy to install, and can provide an intense cardio workout
- Helps improve punching accuracy and overall fitness.



per pc

Code	Size in cm	Color	MRP.
XP507	27cm 58 diameter	Blue/white Red/white Black/white	1300.00



CODE XP 2473

### X-SHOCK BOXING GLOVE

- Made out of High quality PU.
- Injection moulded inner foam
- Non Slip soft Inner Lining
- Reinforced stitching

**INJECTION  
MOULD FOAM**

per pair

Code	Size	Color	MRP.
XP2473	8,10,12,14,16oz	White/Red White/Blue	2050.00







**CODE XP601**  
**JUNIOR BOXING GLOVES**

- High quality PVC.
- filled with poly cotton.

			per pair
Code	Size	Color	MRP.
XP601	4,6,8,10oz	BLUE/RED	650.00
	12,14,16oz		750.00



**CODE XP602**  
**JUNIOR HOOK & JAB PADS**

- High quality PVC.
- Layered foam padding.
- Comfortable and secure grip
- Compact and lightweight design

			per pair
Code	Size	Color	MRP.
XP602	STD	Blue/Red	650.00



**CODE XP603**  
**JUNIOR BOXING KIT**

- High quality PVC
- A 18 inch PVC Punch bag.
- A pair of 6 oz junior gloves
- Extra wide Velcro wrap around wrist easy to open and close

			per set
Code	Size	Color	MRP.
XP603	STD	Blue/Red	1200.00



**CODE XP604**  
**CHAMP SET**

- High quality PVC
- Adjustable speed ball with nylon platform with wooden base
- A pair of junior gloves
- Easy to assemble and disassemble

			per set
Code	Size	Color	MRP.
XP604	Junior	Black/Red	2400.00



**CODE XP605**  
**JUNIOR BOXING KIT**

- High quality PVC
- A 18 inch PVC Punch bag.
- A pair of 6 oz junior gloves & Junior Headguard
- Suitable for 5+ age
- A comprehensive kit that includes Punch bag, gloves, headgear
- Ensures proper protection and support during training sessions

			per set
Code	Size	Color	MRP.
XP605	Junior	Red/Black	1250.00



**CODE XP606**  
**JUNIOR BOXING KIT**

- High quality PVC
- A 24 inch PVC Punch bag.
- A pair of 8 oz boxing gloves
- A pair of straight focus pad
- Suitable for 10+ age

			per set
Code	Size	Color	MRP.
XP606	Junior	Black/Green	2400.00



**CODE XP607**  
**ULTIMATE BOXING SET**

- High quality PU
- A 30 inch PU Punch bag.
- A pair of 8 oz full wrap around boxing gloves
- Headguard
- Nylon Skip rope
- Water bottle
- Punch bag swivel

			per set
Code	Size	Color	MRP.
XP607	Junior	Black/Orange	<b>3350.00</b>



**CODE XP608**  
**XPEED YANKEE SET**

This product can be used as a form of exercise along with developing boxing skills .

The whole equipment needs a little space and has a height adjuster pole allowing it to be used by the individual of every age group and Can be used indoor or outdoor for fun and exercise .

This product comes in vibrant colours which makes it more aesthetic and appealing.  
Suitable for 10+ age

			per set
Code	Size	Color	MRP.
XP608	Junior	Red/Black	<b>4450.00</b>



**CODE XP609**  
**FATHER & SON SET**

- High quality PVC
- A set of 6 oz & 10 oz gloves
- Packed in coloured box

			per set
Code	Size	Color	MRP.
XP609	6, 10oz	Red	<b>1200.00</b>





**XP 301**  
**BELL SWIVEL**  
MRP. 350.00

per pc



**XP 302**  
**PROFESSIONAL SWIVEL**  
MRP. 810.00

per pc



**XP 303**  
**HEAVY DUTY HOOK & SWIVEL**  
MRP. 500.00

per pc



**XP 304**  
**PUNCHBAG HOLDER**  
MRP. 520.00

per pc



**XP 305**  
**SPEED BALL**  
**PLATFORM SET**  
**WITHOUT BALL**  
MRP. 3900.00

per set



**XP 306**  
**TRX MOUNT**  
MRP. 450.00

per pc



**XP307**  
**PUNCHBAG HOOK**  
MRP. 390.00

per pc



**XP 308**  
**PUNCHBAG LIGHT DUTY**  
**BRACKET**  
MRP.1200.00

per pc



**XP 309**  
**PUNCHBAG HEAVY DUTY**  
**BRACKET**  
MRP.3000.00

per pc



**XP 310**  
**MOUTHGUARD SINGLE**  
**SIZE : JUNIOR/SENIOR**  
MRP. 90.00

per pc



**XP 311**  
**MOUTHGUARD DOUBLE**  
MRP. 100.00

per pc



**XP 312**  
**GEL MOUTHGUARD**  
MRP. 150.00

per pc



**XP 313**  
**4 STAND CHAIN SET**  
MRP. 450.00

per pc



**XP 314**  
**FLOOR ANCHOR BRACKET**  
MRP. 350.00

per pc



**XP 315**  
**ADJUSTABLE PLATFORM SET**  
MRP. 9600.00

per set







**CODE XP1501**  
**PU MULTIPURPOSE GLOVE**

- Made out of High quality PU.
- Breathable design for comfort and reduced sweat build-up
- Improved grip and control for better performance
- Adjustable wrist closure for a secure and personalized fit



per pair

Code	Size	Color	MRP.
XP1501	S,M,L	Black/Red	1100.00



**CODE XP1502**  
**CAGE FIGHTING GLOVE**

- Made out of High quality PU.
- Optimal hand and knuckle protection
- Breathable design for airflow and sweat-wicking properties.
- Secure and adjustable fit with hook-and-loop closure system.



per pair

Code	Size	Color	MRP.
XP1502	S,M,L	Black/Red	1150.00



**CODE XP1503**  
**AMATEUR GRAPPLING GLOVE**

- Made out of High quality PU.
- Available in S/M/L
- Optimal hand and knuckle protection
- Breathable design for airflow and sweat-wicking properties.
- Secure and adjustable fit with hook-and-loop closure system.



per pair

Code	Size	Color	MRP.
XP1503	S,M,L	Black/Red	1200.00



**CODE XP1504**  
**STRIKING GRAPPLING GLOVES**

- Made out of High quality PU.
- Available in S/M, L/XL
- Hand crafted shock absorber padding
- Wrap around hook & loop closure

**INJECTION**  
**MOULD FOAM**

per pair

Code	Size	Color	MRP.
XP1504	S/M, L/XL	Black/Red Black/Orange Black/Yellow Black/Green	1700/-



**CODE XP1505**  
**LEATHER MMA GLOVES**

- Made out of High quality Leather.
- Padded thumb.
- Leather/Hook & loop wrap around strap
- Reinforced stitching

**LAYERED**  
**FOAM PADDING**

per pair

Code	Size	Color	MRP.
XP1505	S/M, L/XL	Black/Red Black/Blue	2450.00



**CODE XP1806**  
**SHIN PAD**

- Made out of High quality PU.
- Ultra light weight
- Raised shin and foot ridge
- Hook and look closure system
- Secure fit

**THERMO FOAM**

per pair

Code	Size	Color	MRP.
XP1806	S,M,L, XL	Black/Orange Black/Green Black/Red Black/Yellow	2650.00







**CODE XP2427**  
**JUDO PUNCHING BAG GRAPPLING DUMMY**

Perfect Use: If you are worried about your wrestling practice and you don't have any partner, no need to worry anymore because our MMA dummy is perfect for all kinds of sports such as BJJ-MMA-BOXING-WRESTLING-POLICE TRAINING SELF DEFENCE and many more.

Material & Weight: Our martial arts training equipment for wrestling practice, made of quality PU material. This grappling dummy can be weighted up to 35 to 45 kgs

**Specification**

Sport Judo, Jiu Jitsu  
Brand Xpeed MMA  
Material PU - Black/Brown

per pc

Code	Size	Color	Weight	MRP.
XP2427	110 cm (43.5 inch)	Black/Brown	35-45 kg.	21,500.00



**CODE XP2428**  
**GRAPPLING DUMMY**

- Xpeed wrestling PU dummy used for training in MMA, Wrestling / Grappling sports.
- You can practice all your clinches, throws, takedowns, sweeps, lifts & locks.
- This dummy available is three sizes : SMALL, MEDIUM, LARGE

**Specification**

Sport Judo, Jiu Jitsu

per pc

Code	Size	Color	Weight	MRP.
XP2428	S-140cm (55 inch)	Black	25 kg.	15,300.00
	M-150cm (59 inch)		30 kg.	16,500.00
	L-160cm (63 inch)		40 kg.	17,500.00



**CODE XP2429**  
**GRAPPLING TRAINING DUMMY**

Deal For Training MMA, Muay Thai, Kick Boxing & Jiu-jitsu, Stand Up Strike Training  
 Heavy Duty Micro Fibre Pu  
 Pack of 1 Pc.

**Specification**

Sport Judo, Jiu Jitsu per pc

Code	Size	Color	Weight	MRP.
XP2429	180cm (71 inch)	Black/Brown	40 to 55 kg	16,400.00



**CODE XP1707**  
**MMA THROWING DUMMY PU**

- Constructed with high-quality PU (Polyurethane) for durability.
- Reinforced stitching and sturdy seams ensure long-lasting performance
- The weighted base of the dummy provides stability
- Ideal for improving throws, takedowns, and ground-and-pound techniques.

per pc

Code	Size	Color	Material	MRP.
XP1707	37 Inch x 12 Dia	Black	PU	4500.00 SMALL
	45 Inch x 13 Dia			5700.00 LARGE





**CODE XP1703**  
**ELASTANCE ABDUCUP**

- Offers a comfortable and secure fit
- Reinforced stitching ensures durability and longevity
- Easy-to-clean construction for hygienic and repeated use

Code	Size	Color	MRP.	per pc
XP1703	S,M,L & XL	Black	450.00	



**CODE XP1704**  
**BELLY PROTECTOR PU**

- Ergonomic design offers a comfortable fit
- Lightweight and versatile
- High Density Padding for shock absorption

Code	Size	Color	MRP.	per pc
XP1704	STD	Black	6000.00	



**CODE XP1705**  
**MOUNTAIN WALL**

- Strong PU construction.
- Fitted on a metal frame.
- Target spots for practicing Uppercut, Hook & Side Blow.
- Mounting screws included

Code	Size	Color	Material	MRP.	per pc
XP1705	22.5x15x18 INCH	Black/White	PU Leather	9000.00 14,900.00	



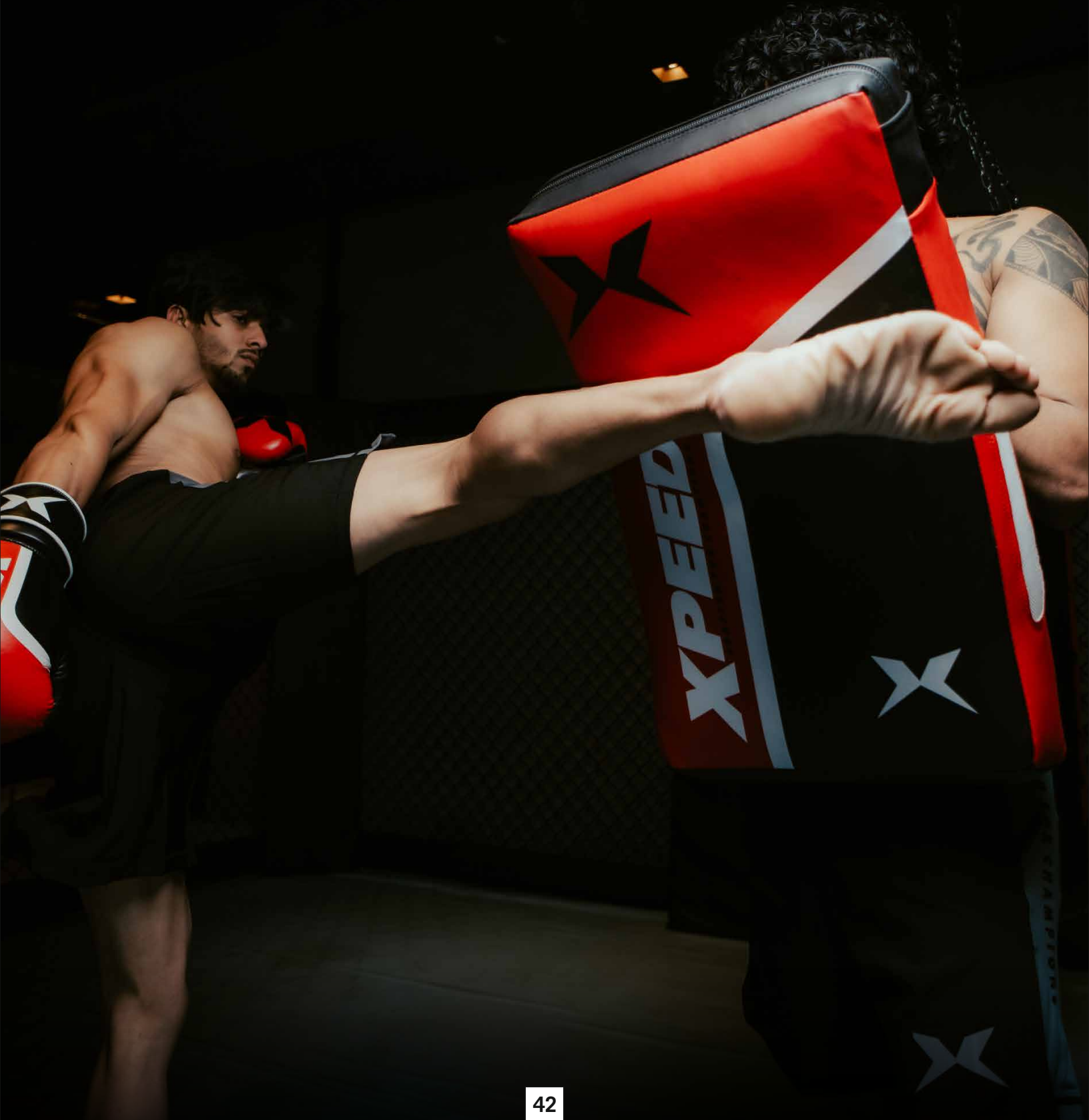



**CODE XP1602**  
**CURVED COACHING SHIELD (per pc)**

- Made out of High quality PU.
- Available in both straight and curved shape for optimal impact absorption
- Ensuring durability, flexibility, and long-lasting performance
- Reinforced handles and adjustable straps.

**STRAIGHT THAI PAD / CURVED THAI PAD**



per pc

Code	Size	Color	MRP.
XP1602	STD	Black/Grey	(Straight) 1550.00 (Curved) 1600.00



**CODE XP1603**  
**CURVED THAI PAD (per pair)**

- Made out of High quality Carbonium PU.
- Reinforced handles and adjustable straps
- Curved shape for enhanced precision and impact absorption.
- Multiple layers of dense foam padding for superior shock absorption



per pair

Code	Size	Color	MRP.
XP1603	39x21x7cm	Black/Green	4000.00



**CODE XP1605**  
**IRANI PAD LEATHER PER PC**

- Made out of High quality Leather.
- Sturdy construction ensures long-lasting performance
- Comfortable to hold and easy to maintain
- Offers excellent grip and impact absorption.
- Provides a realistic target surface for striking training



per pc

Code	Size	Color	MRP.
XP1605	44x26x7cm	Brown	3500.00



**CODE XP1606**  
**IRANI PAD PU PER PC**

- Made out of High quality PU.
- Comfortable to hold and easy to maintain
- Offers excellent grip and impact absorption.
- Provides a realistic target surface for striking training



per pc

Code	Size	Color	MRP.
XP1606	44x26x7cm	Black/Red	2650.00





## ASSASSIN BT TRAINING PUNCH BAGS



75 CM x 30 CM DIA



90 CM x 30 CM DIA



120 CM x 35.5 CM DIA



150 CM x 38 CM DIA



180 CM x 38 CM DIA

**CODE XP201**  
**CARBONIUM PU PUNCHBAG**  
 ( All bags are Excluding chains)

per pc

Code	Size in CM	Color	Weight	MRP.	
				Unfilled	Filled
XP201	60	Black/Sky Blue	10-13kg	1750.00	2700.00
	75	Black/Orange	15-17kg	2000.00	2950.00
	90	Black/Green	20-23kg	2100.00	3100.00
	105	Black/Orange	25-27kg	2300.00	3900.00
	120	Black/Red	30-32kg	2550.00	4200.00
	150	Black/Violet	38-40kg	3400.00	5950.00
	180	Black/Grey	45-50 kg	3800.00	7300.00

## POWER HOUSE PH HEAVY BAGS

### CODE XP203 STRAIGHT BAG ALL LEATHER

( All Bags are including chains)

120X35 CM DIA

- Made out of high quality leather
- Reinforced canvas inner lining
- These bags comes with inside polyfoam lined 20mm



					per pc
Code	Size in CM	Color	Weight	MRP.	
XP203	90X35CM DIA	Black/ white	23-25kg	11,400.00	
	120X35CM DIA		40-42kg	16,200.00	
	150X38CM DIA		45-50kg	22,200.00	
	180X38CM DIA		55-60kg	29,400.00	



### CODE XP204 UPPER CUT PUNCH BAG ALL LEATHER

( All Bags are including chains)

120X45 CM DIA

- Made out of high quality leather
- Reinforced canvas inner lining



					per pc
Code	Size in CM	Color	Weight	MRP.	
XP204	120X45 CM DIA	Black/ white	45-50kg	18,600.00	



### CODE XP205 MAIZE PUNCH BAG ALL LEATHER

( All Bags are including chains)

60X18 CM DIA

- Made out of high quality leather
- Reinforced canvas inner lining



					per pc
Code	Size in CM	Color	Weight	MRP.	
XP205	60X18CM DIA	Black/white	24kg	8400.00	



**CODE XP202**  
**CANVAS PUNCHBAG**

per pc

Code	Size in CM	Color	Weight	MRP.	
				Unfilled	Filled
XP202	90X30CM	White	20-22kg	930.00	2050.00
	120X30CM		30-32kg	1300.00	2750.00
	150X30CM		35-37kg	1750.00	3300.00



**CANVAS PUNCHBAG**

**CODE XP206**  
**NEVATEAR PVC PUNCH BAG**

per pc

Code	Size in CM	Color	Weight	MRP.	
				Unfilled	Filled
XP206	90X30CM	Black	22-23kg	1600.00	2600.00
	120X30CM		30-32kg	2300.00	3650.00
	150X30CM		38-40kg	2500.00	4400.00



**NEVATEAR PVC PUNCH BAG**

**JUMBO PUNCHBAG**

**CODE XP207**  
**ALL LEATHER**

120X50 CM DIA  
(All bags are Including chains)

- Made out of high quality leather
- Reinforced canvas inner lining
- These bags comes with inside polyfoam lined 20mm



per pc

Code	Size in CM	Color	Weight	MRP.	
				Unfilled	Filled
XP207	120X45CM Dia	Black/White	60x65kg	19,800.00	23,400.00



**ALL LEATHER**

**CODE XP208**  
**ALL HEAVY DUTY PU**

120X50 CM DIA  
(All bags are Including chains)

- Made out of high quality PU
- Reinforced canvas inner lining
- These bags comes with inside polyfoam lined 20mm



per pc

Code	Size in CM	Color	Weight	MRP.	
				Unfilled	Filled
XP208	120X45CM Dia	Black/Red	57x60kg	12,050.00	15,600.00



**ALL HEAVY DUTY PU**

# BATTLER BT HEAVY BAGS

## CODE XP209

### STRAIGHT PUNCH BAG LEATHER/PU

(All Bags are including chains)

- Made out of combination of good quality heavy PU & crackle buffalo premium quality leather with closer at top.
- D ring at bottom
- Reinforced canvas inner lining
- These bags comes with inside polyfoam lined 20mm



per pc

Code	Size in CM	Color	Weight	MRP.
XP209	120x35CM Dia	Black/	35-40kg	16,200.00
	150x40CM Dia	Crackle	45-50kg	22,200.00
	180x40CM Dia	Leather	55-60kg	28,200.00



## CODE XP210

### DOUBLE BODY PUNCH BAG LEATHER/PU

(All Bags are including chains)

- Made out of combination of good quality heavy PU & crackle buffalo premium quality leather with closer at top.
- D ring at bottom
- Reinforced canvas inner lining
- These bags comes with inside polyfoam lined 20mm

per pc

Code	Size in CM	Color	Weight	MRP.
XP210	132x35CM Dia	Black/ Crackle Leather	65-70kg	19,500.00



# BATTLER BT HEAVY BAGS

## CODE XP214

### UPPER CUT PUNCH BAG LEATHER/PU

(All Bags are including chains)

- Made out of combination of good quality heavy PU & crackle buffalo premium quality leather with closer at top.
- D ring at bottom
- Reinforced canvas inner lining
- These bags comes with inside polyfoam lined 20mm



per pc

Code	Size in CM	Color	Weight	MRP.
XP214	120x45CM Dia	Black/ Crackle Leather	45-50kg	18,000.00



## CODE XP215

### PEAR BAG (SUSPENSION SYSTEM)

(All Bags are including chains)

- Made out of combination of good quality heavy PU and crackle buffalo premium quality leather with zip closer at top.
- Reinforced canvas inner lining.
- This bag comes with Suspension set



per pc

Code	Size in CM	Color	Weight	MRP.
XP215	85x29CM Dia	Black/ Crackle Leather	50-52kg	21,600.00



# REVOLUTION RT PUNCH BAGS

**CODE XP212**

**WRECKING PUNCH BAG HEAVY DUTY PU**

(All Bags are including chains)

61X23 CM DIA

- Made out of high quality PU
- Reinforced canvas inner lining

per pc

Code	Size in CM	Color	Weight	MRP.	
XP212	61x23CM Dia	Black/Green	32-35kg	PU	Leather
		Black/Red		7800.00	12,600.00
		Black/Orange			
		Black/Gery			



# REVOLUTION RT HEAVY DUTY PUNCH BAGS

**CODE XP213**

**REVOLUTION RT HEAVY DUTY PUNCH BAGS**

(All Bags are including chains)

- Made out of high quality heavy duty PU with lace closure at top
- Reinforced canvas inner lining
- These bags comes with inside polyfoam lined 20mm



per pc

Code	Size in CM	Color	Weight	MRP.
XP213	90x35cm Dia	Red/Black	23-25kg	5700.00
	105x35cm Dia	Grey/Black	27-30kg	6100.00
	120x40cm Dia	Green/Black	32x35kg	7650.00
	150x40cm Dia	Black/Red	40x45kg	8600.00
	180x40cm Dia	Orange/Black	50-55kg	9800.00
	210x40m Dia	Orange/Black	60-65kg	13,400.00



90x35cm DIA



105x35 cm DIA



120x40CM DIA



150x40CM DIA



180x40CM DIA





**CODE XP1236  
STANDING BAG**

**MATERIAL** - Our inflatable punching bag made with thicker environmentally friendly PVC material, which ensures security and durability. Recommended for Adults  
**HIGH ELASTICITY** -- 6 Feet height punch target tower, Rugged vinyl construction can withstand an onslaught of kicks and punches, and will always bounce back up for more  
**HOW TO USE** -- Open the Pocket in the bottom and fill sand into it to give it the weight needed to stay on the ground, cover the stopper closely.

per pc

COMPONENTS	DETAILS
Punching Bag	Padded PU foam, Outer::PVC Weight: Size:46cm (dia.) x 190cm (H)
Protective cover	Outer: Protection, Cover : PU Foam/PVC
Inner Pole	Inner: Iron Pole with base
Base	Synthetic fiber PVC

Code	Size	Color	MRP.
XP1236	80x18x23 INCH	Black	31,200.00



**CODE XP1239  
HEAVY BOXING TRAINER WITH PROTECTION  
COVER**

- Durable and high-quality construction for intense training
- Includes a protective cover to enhance longevity and maintain shape
- Provides a safe and effective way to practice punches and strikes
- Sturdy design ensures stability during high-impact training
- Ideal for improving striking skills, power, and hand-eye coordination

**Total height:195cm** per pc

COMPONENTS	DETAILS
Punching Bag	Padded PU foam, Outer::PVC Weight: Size:42cm (dia.) x 132cm (H)
Protective cover	Outer: Protection, Cover : PU Foam/PVC Size: 42cm (dia.) x 27 cm (H)
Spring set	Inner: Rubber / Steel, Cover : PE Spring size: 16cm (dia.) x 31cm (H)
Base	Materials : HDPE Dims: 810mm (dia.) x 35.5cm (H) The base tank with water is about 140 kgs

Code	Size in INCH	Color	MRP.
XP1239	78 inch apx.	Black	46,800.00



**CODE XP1240****BOXING MAN WITH PROTECTION COVER**

- Improved boxing rubber, filled with urethane foaming
- Elastomeric spring action.
- Plastic base with space.

COMPONENTS	DETAILS
Dummy	Material : PU, Size : 69cm (H) x 53cm (W) Weight: 5.5kg±100g
Spring set	Inner : Rubber/Steel, Cover : PE Spring size : 17cm (dia.) 33cm (H).
Cover	Inner: PU FOAM / OUTER : PVC SHELL SIZE : OUTER DIA DIA. : 29cm / thickness:cm height : 36cm
Base	Materials : HDPE Dims : 530mm (dia.)x71 cm (H)/6.5kgs Base with water is about 110-120kgs

per pc

Code	Size in cm	Color	MRP.
XP1240	69 cm (H)x53cm (w)	Black	58,800.00

158  
cm  
to  
178  
cm

**CODE XP1242**  
**PUNCHING BALL STAND**

- Constructed from PU/Plastic/Metal.
- Ball made out of PU.
- Spring action
- Plastic base with space

**Total product height: 125~160 cm** per set

COMPONENTS	DETAILS
Punching ball	Material : PU, Size :dia 200 x (H) 260 mm Weight: 750±70g
Protective Cover	Material: PU Foam /Size:dia. 70x (H) 125mm
Top Tube	Material: Metal/Size: dia. 22.2x(T)1.2 x (L)480mm
Bottom Tube	Material: Metal/Size: dia. 25.4x(T)1.2 x (L)480mm
Spring Set	Housing : ABS Spring: Steel, 7mm thick, 38.9mm dia, 140mm H
Base	Material : HDPE Wight: 1.8kgs Dims: 490mm dia x 250mm H, with water is about 30kgs.

Code	Size in cm	Color	MRP.
XP1242	69 cm (H)x53cm (w)	Black	10,200.00

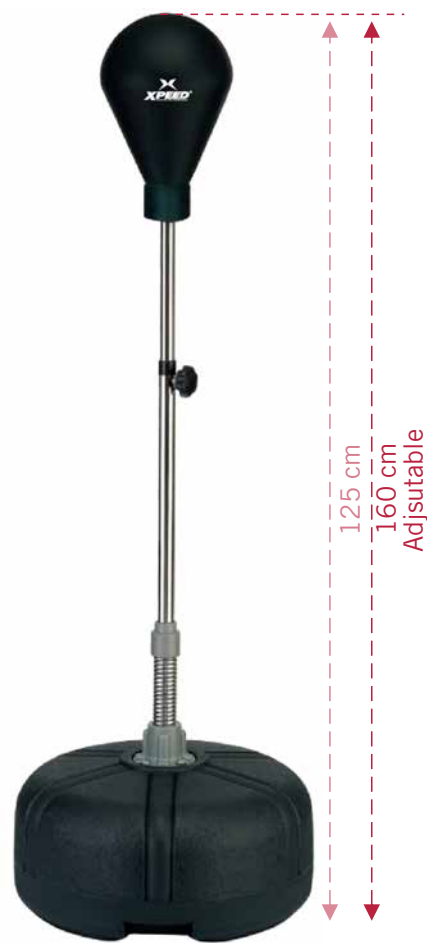

**CODE XP1245**  
**ROTABAR WITH PUNCHING BALL**

- Adjustable height 149-187 cm
- Boxing Training, Kick Training, Fitness Shaping, Speed Training, Reaction Training, Improve Intelligence, and Release Stress.
- The self-contained suction cup can be firmly fixed on the ground, so you don't have to worry about shaking during training.
- Install the product according to the manual, installation and storage can be completed in a few minutes. Fill the base with a mixture of sand and water to improve stability.

per set

COMPONENTS	DETAILS
Punching ball	Material : PU, Size : 20cm x 26 cm
Adjustable height	149x187cm
Base	Material : HDPE Wight: 1.8kgs Dims: 50cm dia x 50cm H

Code	Size in cm	Color	MRP.
XP1245	20cm x 26 cm	Black	22,800.00



**CODE XP1243**  
**PUNCH KICK TRAINER**

- Constructed from Metal/Plastic
- Adjustable target pads.
- Plastic base for filling water

per set

COMPONENTS	DETAILS
Spring	5.0mm (dia.)
Kicking Bar	With 4pcs kicking bar (L: 50cm), and 4 adjustable angle
Base	Material : HDPE Size: 630mm (dia.) with water is about 60kgs

Code	Size in mm	Color	MRP.
XP1243	630 mm	Black/Red	19,800.00



**CODE XP1244**  
**PUNCH KICK MASTER**

- Constructed from Metal/Plastic
- Adjustable target pads.
- Plastic base for filling water

per set

COMPONENTS	DETAILS
Spring	5.0mm (dia.)
Kicking Bar	With 4pcs kicking bar (L: 50cm), and 4 adjustable angle
Base	Material : HDPE Size: 630mm (dia.) with water is about 60kgs

Code	Size in mm	Color	MRP.
XP1244	630 mm	Black	87,000.00





**CODE XP5001  
WRESTLING RING**

**Details**

Height:

1.25"-2" | 31.8-50.8 mm

Width:

29.53' | 9 m (Diameter)

Length:

29.53' | 9 m (Diameter)

Area:

684 ft<sup>2</sup> | 63.5 m<sup>2</sup> (Contest)

Central Circle Diameter: 39.37" | 1 m

Central Circle Thickness: 4" | 10 cm

Passivity Zone (Orange Zone): 39.37" | 1m

Overall Width: 39.37" | 12 m

Total Competition Area: 1550 ft<sup>2</sup> | 144 m<sup>2</sup> Surface

Materials: Polyurethane or Rubber foam

**LIGHT VERSION**

Code	SIZE IN MTR	QTY, MATT	MRP. 50 mm	MRP. 60 mm	MRP. 70 mm
XP5001	1m x 2 m	1 matt	9600.00	12,000.00	13,200.00
	6m x 6 m	18 matt	1,72,800.00	2,16,000.00	2,37,600.00
	8m x 8 m	32 matt	3,07,200.00	3,84,000.00	4,22,400.00
	10m x 10 m	50 matt	4,80,000.00	6,00,000.00	6,60,000.00
	12m x 12 m (OCTAGON)	68 matt	6,52,800.00	8,16,000.00	8,97,600.00
	12m x 12 m	72 matt	6,84,000.00	8,64,000.00	9,50,400.00

**HEAVY VERSION**

Code	SIZE IN MTR	QTY, MATT	MRP. 50 mm	MRP. 60 mm	MRP. 70 mm
XP5001	1m x 2 m	1 matt	11,400.00	13,800.00	14,400.00
	6m x 6 m	18 matt	2,05,200.00	2,48,400.00	2,59,200.00
	8m x 8 m	32 matt	3,64,800.00	4,61,600.00	4,60,800.00
	10m x 10 m	50 matt	5,70,000.00	6,90,000.00	7,20,000.00
	12m x 12 m (OCTAGON)	68 matt	7,75,200.00	9,38,400.00	9,79,200.00
	12m x 12 m	72 matt	8,20,800.00	9,93,600.00	10,36,800.00

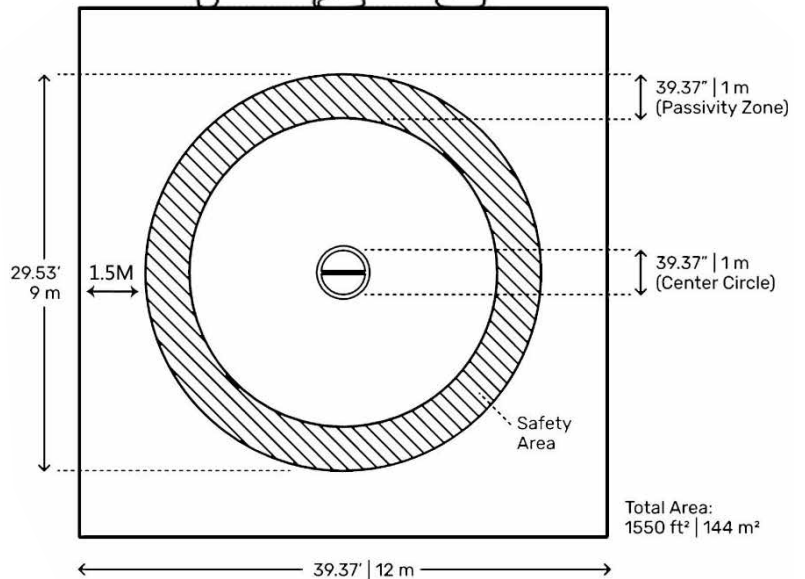

**PROFESSIONAL RING**  
(12X12MTR COURT / 72 MATS)

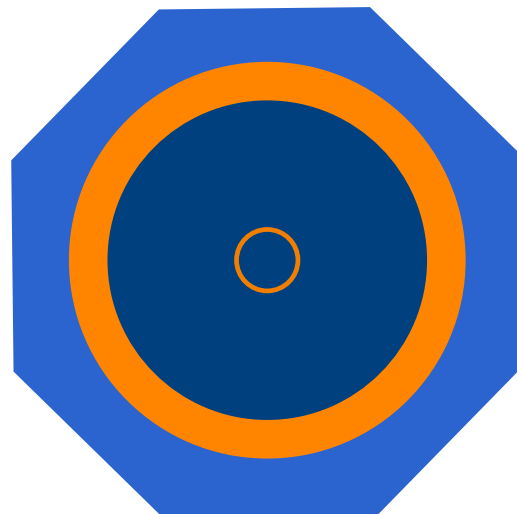

**OCTAGON RING**  
(12X12MTR COURT / 68 MATS)



**WRESTLING ARENA**

(12X12MTR COURT / 72 MATS)

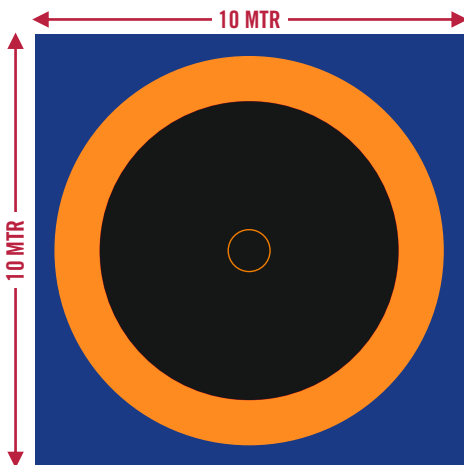

DIMENSION: 10X10MTR  
NO OF MATS REQUIRED: 50  
AVAILABLE THICKNESS: 50MM/60MM/70MM  
COVER: TRI COLOR / 600 GSM  
AVAILABLE QUALITY: LIGHT / FEDERATION HEAVY

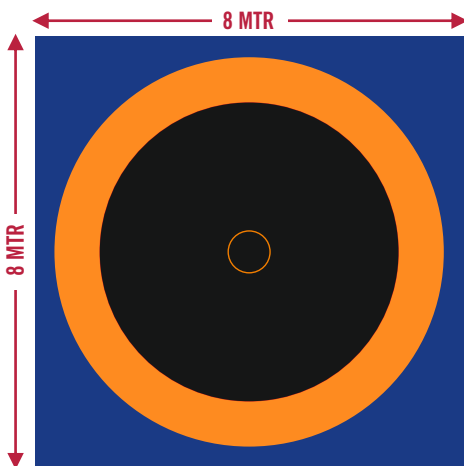
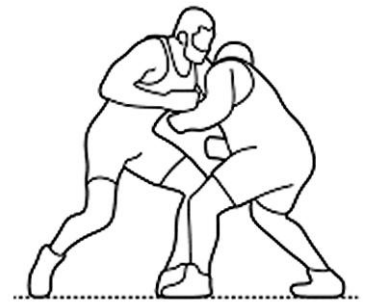

DIMENSION: 8X8MTR  
NO OF MATS REQUIRED: 32  
AVAILABLE THICKNESS: 50MM/60MM/70MM  
COVER: TRI COLOR / 600 GSM  
AVAILABLE QUALITY: LIGHT / FEDERATION HEAVY

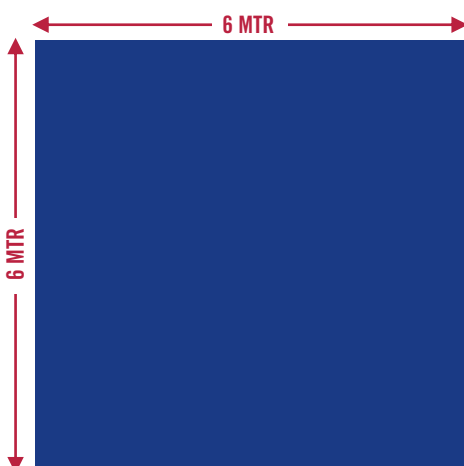

DIMENSION: 6X6MTR  
NO OF MATS REQUIRED: 18  
AVAILABLE THICKNESS: 50MM/60MM/70MM  
COVER: SINGLE COLOR / 600 GSM  
AVAILABLE QUALITY: LIGHT / FEDERATION HEAVY

**WRESTLING MAT COVER ONLY**

Code	DESCRIPTION	SIZE IN MTR	MRP.
XP5001	Single colour 600 gsm	6 m x 6 m	49,900.00
	Tricolour 600 gsm	8 m x 8 m	1,04,500.00
	Tricolour 600 gsm	10 m x 10 m	1,37,300.00
	Tricolour 600 gsm	12 m x 12 m	2,09,100.00
	Tricolour 800 gsm	12 m x 12 m	2,16,000.00



**CODE XP5002**  
**JUDO SPORTSMAT**

Judo Competition Area

Height: 1.5"-2" | 38.1-50.8 mm

Width: 26.25 -32.8 | 8-10 m (Contest)

Length: 26.25 -32.8 | 8-10 m (Contest)

Area:

689-1076 ft<sup>2</sup> | 64-100 m<sup>2</sup> (Contest)

Danger Zone: 35.43"-39.37" | .9-1 m

Safety Area: 9.84 | 3 m

Start Position Separation: 9.84'-12' | 3-3.64 m

Overall Area (Clearance): 2422-2755 ft<sup>2</sup> | 225-256 m<sup>2</sup>

Surface Materials: Polyurethane foam, rubber foam

Available Colors

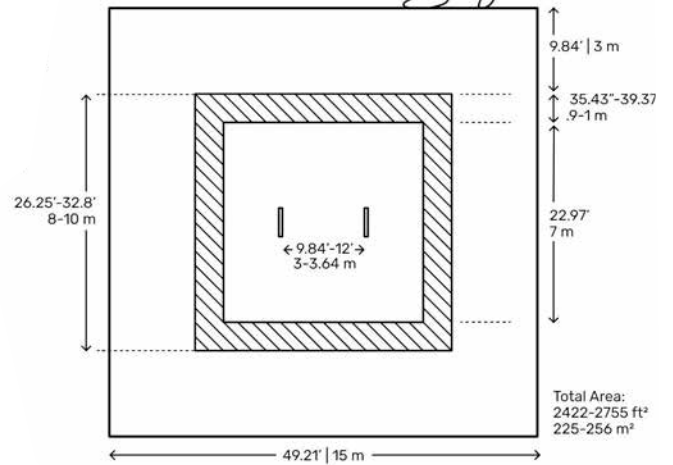

Code	MATERIAL	THICKNESS & SIZE	Density	MRP.
XP5002	EPE FOAM + JSR BONDED PU FOAM	40 mm (2 x 1 mtr)	150-160	9000.00
		50 mm (2 x 1 mtr)		12,900.00
		50 mm (2 x 1 mtr)		14,400.00
		50 mm (2 x 1 mtr)		15,300.00

Regular

Professional

**Available Colors**

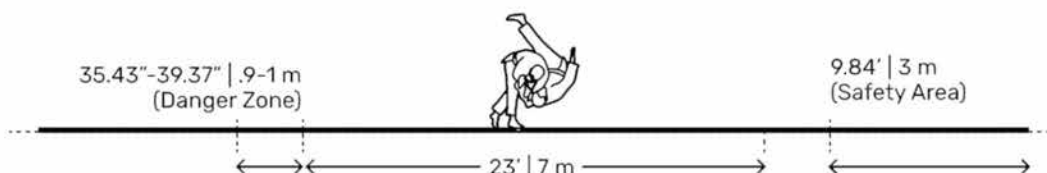
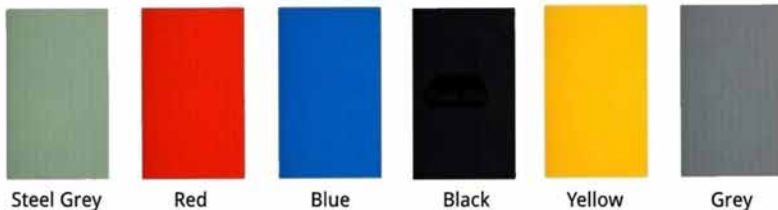
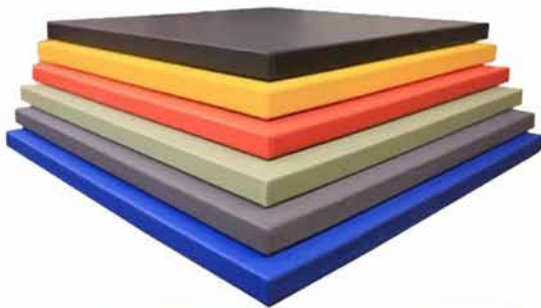



# JUDO SPORTMATS



## JUDO MAT TYPES

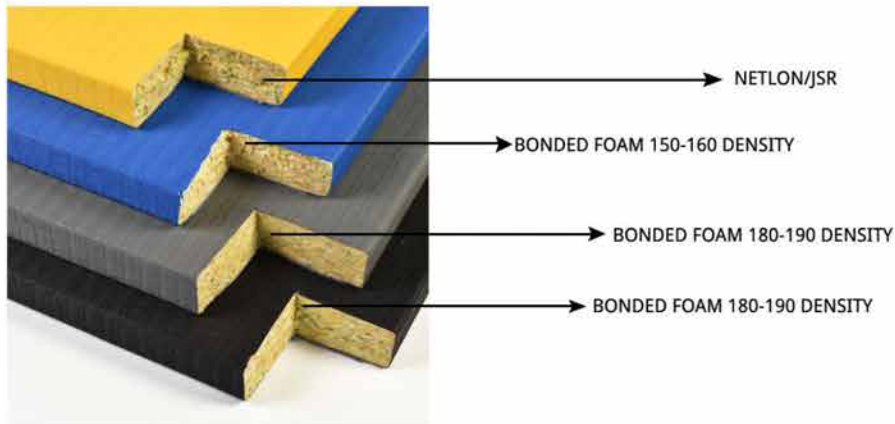

## PRODUCTION IMAGES

**HEAVY BONDED  
COVERS WITH BEST  
ANISKID RUBBER  
SURFACE**

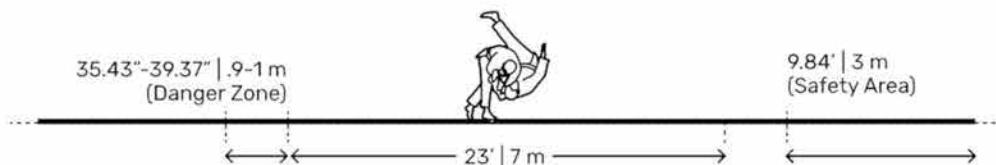



**CODE XP5003**  
**WUSHU SANDA**

Sanda Arena (Ring)

Specification: 8x8x0.8m

Feature: the frame is made of high-quality metal rectangular tube, and the platform is formed by multilayer plate, flexible layer and cover.

There are cushioning pads on the back of board. Protection pads with 2m width and 0.3m thickness are equipped around the platform.

**Sanda Training Mat**

Specification: 8x8x0.06m/8x8x0.05m

Materials: Inside mat is made of PE and high-elastic foam EVA, and the cover is rubber faced PVC leather which is anti-slip and washable.

**PRICE WITHOUT PLATFORM**

Code	DESCRIPTION	SIZE	MRP.
XP5003	20 PCS CRASH MAT	2 M X 2 M X 30 CM	13,20,000.00
	32 PCS HEAVY 50MM JSR MAT WITH NON TEARING COVER		
	1 PCS COVER	8 M x 8 M (RED/BLUE)	



PLATFORM INSTALLATION

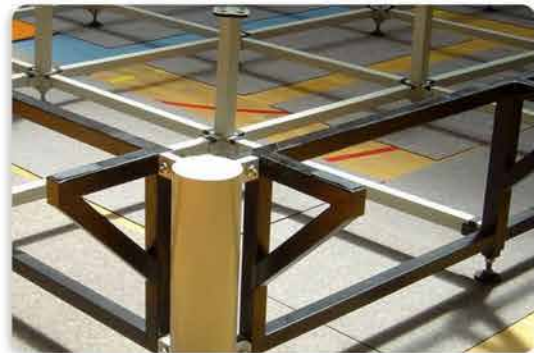

STAGE 2 PLY INSTALLATION



STAGE 3 MATS INSTALLATION



STAGE 4 FINAL COURT

**WUSHU SET**

CRASH MATS: 2MX2MX30CM (20 PC)  
JSR MATS: 1X2 MTRX50MM (32PC)  
COVER: 8X8 MTR (1PC-BLUE&RED)





CODE XP5004

### MMA CAGE RING MMA Cage Championship (customizable) - IMMAF standards

MMA Cage (customizable) - Championship

Octagonal IMMAF standards compliant (3 sizes). Metal platform structure, 1 inch plywood boards, PVC cover, fully customizable (print logos on poles, PVC cover, wraps, etc). Stairs included, one or two doors. Contact us for any special request.

**\*Elevated Platform Model**

Code	Size in Feet	MRP.
XP5004	24x24 ft	9,24,000.00
	28x28ft	10,08,000.00
	30x30ft	10,92,000.00

**\*Floor Model**

Code	Size in Feet	MRP.
XP5004	16x16ft	3,72,600.00
	18x18ft	4,08,000.00
	20x20ft	4,38,000.00

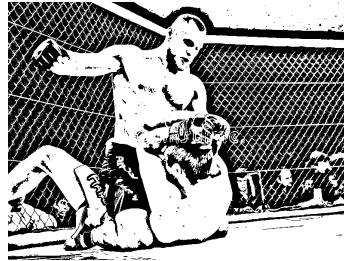

\*Specific Size on demand

\* Installation Extra



20"



**SINGLE ENTRANCE**

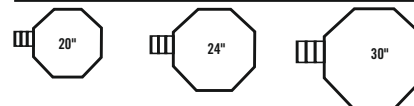

**DUAL ENTRANCE**

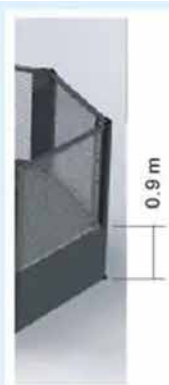
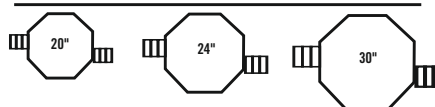



## CODE XP5005 BOXING RING

### Boxing Ring Details

Size : 24x24 (platform) 20x20 feet (rope to rope)  
and: 20x20 (platform)16x16 feet (rope to rope )

pipe 4 inch round, Rope 30 MM thick made of hemp,  
rope color red, blue, white sewed by non tearing

proof plywood  
2 spit bins and 3 stairs

Structure made of heavy iron angle size: 50 x6 mm  
heavy quality painted structure, and foldable fitted  
by nut bolt easy assembling system, vertical ms iron

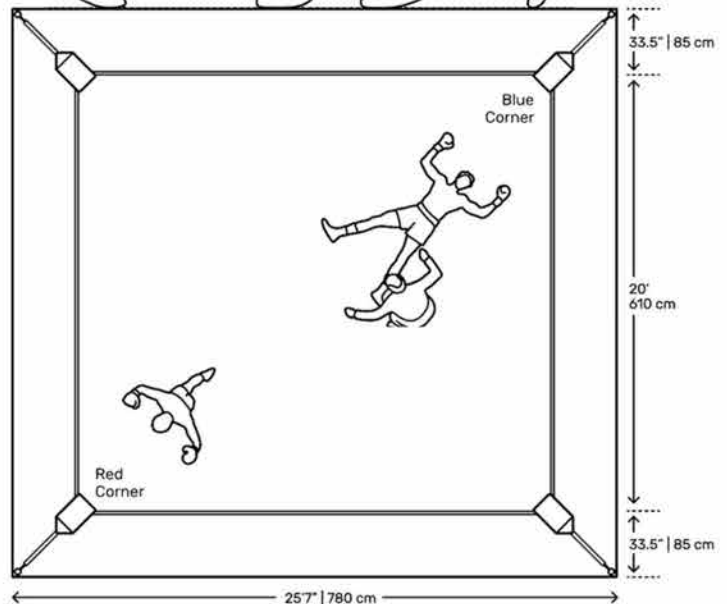
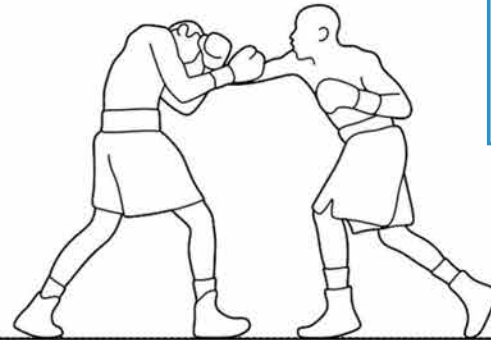

Code	Discription	Size in FT	MRP.
XP5005	Jute Rope with cover Without side skirting	24 x 24 ft	8,40,000.00
	Steel wire with cover 4 side skirt cover	24 x 24 ft	9,42,000.00

\*Specific Size on demand

\* Installation Extra

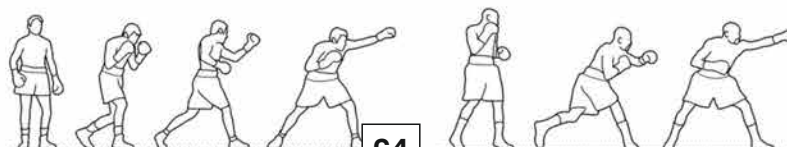
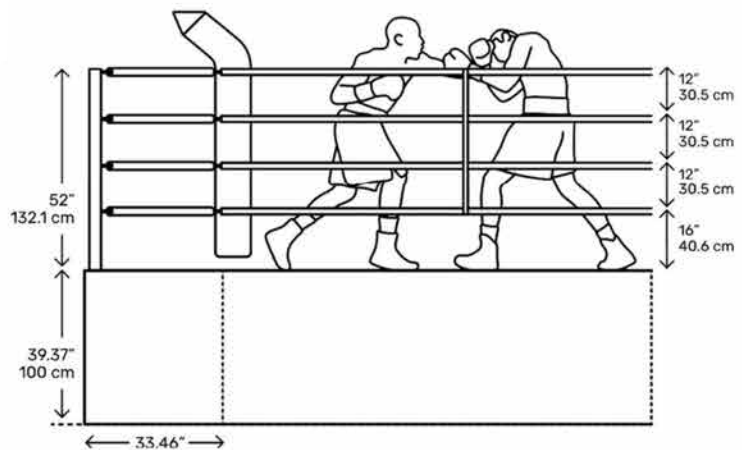



## CODE XP5006 BOXING RING FLOOR

- Metal foam construction
- Anti-rust powder coated
- Durable paint
- Interlocking mat floor 25 mm
- 02 ring stools included
- Fully collapsible

Code	Total Area	Inside Area	MRP.
XP5006	16'x16'/488cm	14'x14'/427cm	3,84,000.00
	14'x14'/427cm	12'x12'/366cm	2,25,600.00
	12'x12'/366cm	10'x10'/305cm	2,04,000.00



## CODE XP5007 CHAMPIONSHIP BELT

- BRASS PLATE CONSTRUCTION
- METAL BUCKLE CLOSURE
- HIDE LEATHER BELT
- CUSTOM DESIGNS POSSIBLE

per pc

Code	MRP.
XP5007	ON REQUEST



## CODE XP5008 RING GONG

- Metal & wood construction
- Brass hammer

per set

Code	MRP.
XP5008	4800.00



## CODE XP5009 BOXING TIMER

- Ideal for boxing or circuit training
- Loud sounder for noisy gym environment
- High visibility

per pc

Code	MRP.
XP5009	9600.00



**CODE XP5010**  
**FIGHT BOTTLE 1 LTR.**

- Food grade plastic construction.
- Extended pipe with lid for inserting in mouth
- Leak proof

per pc

Code	Colour	Capacity apx.	MRP.
XP5010	White	0.95 ltr	450.00



**CODE XP5011**  
**SPONGE**

- Soft foam

per pc

Code	Dimension (apx.)	MRP.
XP5011	19cm x14cm x 5cm (7.5"x5.5"x2")	280.00



**CODE XP5012**  
**TURN BUCKLE COVER**

- Nylon construction
- Foam padded
- Hook & loop closure

per set

Code	Length	Set	MRP.
XP5012	1 m Approx.	16 pcs (4 red, 4 blue, 8 white)	8650.00



**CODE XP5013**  
**RING ROPE**

- Polypropylene (PP) twisted rope
- 25mm thick plastic

per pc

Code	Length	MRP.
XP5013	137 m (450') apx.	31,800.00



**CODE XP5014**  
**METAL RING ROPE**

- 8 mm metal wire construction
- Covered with nitrile foam tub
- pre assembled for competition boxing ring 4 ropes

per set

Code	MRP.
XP5014	89,400.00



**CODE XP5015**  
**TURN BUCKLE**

- Forged metal construction

per set

Code	Set	MRP.
XP5015	16 pcs	7700.00



**CODE XP5016**  
**ROPE SPACER**

- Constructed from Nylon material
- Hook & loop closure

per set

Code	Set	MRP.
XP5016	8 pcs	2400.00



**CODE XP5017**  
**RING STAIR**

- Metal construction

per pc

Code	Dimensions	Colour	MRP.
XP5017	34x24x32"	Blue	9600.00



**CODE XP5018**  
**RING COVER NYLON**

- Crafted from nylon material
- Eyelets for tying ropes

per pc

Code	Dimensions	MRP.
XP5018	8 mtr (26.5'x26.5')	53,500.00



**CODE XP5019**  
**RING COVER CANVAS**

- Crafted from canvas material
- Eyelets for tying ropes

per pc

Code	Dimensions	MRP.
XP5019	8 mtr (26.5'x26.5')	51,100.00



**CODE XP5020  
CORNER PAD**

- They are made from durable Nevatear materials
- Constructed with high-density foam padding for impact absorption
- Reinforced stitching ensures the pad's integrity under pressure
- Designed to fit securely over the corners of the boxing ring (1 red 1 blue 2 white)

			per set
Code	Set	Color	MRP.
XP5020	Set of 4 pcs	Blue, Red, White	10,800.00



**CODE XP5021  
RING PADDING**

- 25mm thick expandable foam
- 1.2 x 2m x 28 sheets

			per set
Code	Sheets	MRP.	
XP5021	28 pcs	33,600.00	



**CODE XP5022  
ROPE COVER**

- Nylon material
- Hook & loop closure
- Ideal for competition boxing ring
- Set includes : 8 Red/White, 8 Blue/White  
\*cover only, rope not included

			per set
Code	Size length	MRP.	
XP5022	610cm/20' each cover	27,000.00	







**CODE XP1801**  
**PU KARATE GLOVE**

- Made out of High quality PU.
- Durable and Long-Lasting
- Offers Protection and Comfort for Hands.
- Secure Fit for Enhanced Martial Arts Performance.
- Designed for Flexibility and Ease of Movement.



Code	Size	Color	per pair MRP.
XP1801	S/M & L/XL	Red, Blue	950.00



**CODE XP1802**  
**PVC POINT GLOVE**

- Made out of High quality PVC.
- Designed for Precision and Comfort.
- Ideal for Pointing, Sorting, or Delicate Handling.
- Elasticated closure



Code	Size	Color	per pair MRP.
XP1802	Junior, Senior	Red, Blue	700.00



**CODE XP1803**  
**PU KARATE SHIN PAD**

- Made out of High quality PU.
- Secure and Comfortable Fit
- Injection mould foam padding
- Secure and Comfortable Fit
- Superior Quality Pad for Impact Absorption.
- Lightweight and Flexible



Code	Size	Color	per pair MRP.
XP1803	S,M,L,XL	Red, Blue	2150.00



**CODE XP1804**  
**PVC KARATE SHIN PAD**

- Made out of High quality PU.
- Secure Fit for Enhanced Safety and Comfort.
- Superior Quality Pad for Impact Absorption.
- Lightweight and Flexible for Unrestricted Movement.

**INJECTION MOULD FOAM** (P)

Code	Size	Color	per pair MRP.
XP1804	S,M,L,XL	Red, Blue	950.00



**CODE XP1814**  
**KARATE CHEST GUARD**

- Material: PU
- Comfortable, Durable, Synthetic Lightweight padding
- Elasticated back closure
- Synthetic lightweight padding

(P)

Code	Size	Color	per pc MRP.
XP1814	S,M,L,XL	WHITE	1800.00



**CODE XP1815**  
**KARATE HEADGUARD**

- 100% high quality Synthetic leather
- Flexible way velcro closure
- Suitable for multi-purpose contact sparring games
- Offers maximum protection to whole head, without impairing hearing
- Open face design allows ventilation"
- Ideal for Practice And Competition

**INJECTION MOULD FOAM** (P)

Code	Size	Color	per pc MRP.
XP1815	S,M,L,XL	Red, Blue	1100.00



**CODE XP1805  
CHEST GUARD**

- Made out of High quality PU.
- Reversible
- Durable and Reversible Design for Versatility.
- Offers Protection and Comfort
- Excellent Impact Absorption.



per pc

Code	Size	Color	MRP.
XP1805	S,M,L,XL	Red, Blue	1900.00



**CODE XP1808  
HEADGUARD**

- Made out of High quality PU
- Adjustable straps and hook-and-loop closure
- Easy to get a secure, custom fit
- Comfortable and flexible



per pc

Code	Size	Color	MRP.
XP1808	S,M,L,XL	Red, Blue	1100.00





**CODE XP1901**  
**KARATE GI CHAMPION**  
**(LIGHTWEIGHT) 200 GSM**

- Loose Fit Type
- Made from 100% Cotton
- Elasticated Waist Band with drawstring.



per set

Code	Size in CM	Color	MRP.
XP1901	100,110,120 CM	WHITE	2050.00
	130,140,150 CM		2400.00
	160,170,180 CM		2750.00



**XP 1902**  
**KARATE GI MASTER**  
**(HEAVY WEIGHT) 360 GSM**

- Loose Fit Type
- Made from 100% Cotton
- Elasticated Waist Band with drawstring.



per set

Code	Size in CM	Color	MRP.
XP1902	130,140,150 CM	WHITE	2850.00
	160,170,180 CM		3300.00
	190, 200, CM		3400.00



**CODE XP1904**  
**ORIGIN KARATE DRESS**

- Cotton/Polyester Twill weave
- Light weight
- Ideal for beginners
- Comfort in action

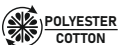

per set

Code	Size in CM	Color	MRP.
XP1904	100 CM to 180CM	WHITE	1200.00
	190 CM		1300.00
	200 CM		1450.00



**CODE XP1906**  
**KARATE BELTS**

- Poly cotton fabric.
- Strong web tape insert.
- 7 precise stitchings Size : 240, 280
- Colours : White, Yellow, Orange, Green, Blue, Brown, Red, Black



POLYESTER COTTON		per pc	
Code	Size in MTR	Color	MRP.
XP1906	2.5 MTR. 3 MTR 3.3 MTR	Multi-colour	500.00

**CODE XP1903**  
**TAEKWONDO DOBOK CHAMPION**

- Lightweight Polyester cotton blend 190 GSM apx.
  - Traditional Rib weave.
  - Elasticated waist band with drawstring.
- Size Available:100cm x 180cm (\* Belt not Included)



POLYESTER COTTON		per set	
Code	Size in CM	Color	MRP.
XP1903	100,110,120 CM	WHITE	1550.00
	130,140,150 CM		1850.00
	160,170,180 CM		2150.00

**CODE XP1905**  
**ORIGIN TAEKWONDO DRESS**

- Cotton/Polyester Twill weave
- Light weight
- Ideal for beginners
- Comfort in action

POLYESTER COTTON		per set	
Code	Size in CM	Color	MRP.
XP1905	100 CM to 180CM	WHITE	1200.00
	190 CM		1300.00
	200 CM		1450.00





**CODE XP1907**  
**JUDO CHAMPION INCL.**  
**BELT 300 GSM**

- Made from Poly/Cotton
- Durable Contest Gi
- Lightweight and comfortable material



per set

Code	Size in CM	Color	MRP.
XP1907	100CM	Blue, Red	1950.00
	110CM		2100.00
	120CM		2200.00
	130CM		2350.50
	140CM		2450.00
	150CM		2600.00
	160CM		2700.00
	170CM		2850.00
	180CM		2950.00
	190CM		3100.00
200CM	3200.00		





**CODE XP2001**  
**SINGLE FAN PAD**

- Made out of High quality PU/PVC.
- Non-slip wrist strap.
- Design for heavy hit.
- Used for teakwondo and other martial.

			per pc
Code	Size	Color	MRP.
XP2001	STD	Black	850.00



**CODE XP2002**  
**DOUBLE FAN PAD**

- Made out of High quality PU/PVC.
- Non-slip wrist strap.
- Rigid EVA Padding for clap Sound.
- Grooved Handle.

			per pc
Code	Size	Color	MRP.
XP2002	STD	Red	1000.00



**CODE XP2004**  
**BREAST GUARD**

- Flexible round the armholes with two semi-rigid polyethylene cups.
- An effective replacement for a sports bra.
- Polyester fabric for more resistance.

			per pc
Code	Size	Color	MRP.
XP2004	S,M,L	White	1500.00



**XP2472**  
**MARTIAL ART FOAM NUNCHAKU**

- Material: Foam Covered on the PVC tube inner and stainless steel electroplating chain
- Stick Length Size : 30cm, chain 18cm
- Taekwondo beginners and children's great training products.

			per pc
Code	Size	Color	MRP.
XP2472	30x18cm	Black	1100.00







**CODE XP2467**

## TAEKWONDO FORMING HEADGUARD

- Material: One-time molding, NBR foam + PU coating, there is a hook and loop connection at the chin, which is convenient to adjust the size and tightness of wearing.
- The production process is exquisite, light, soft, comfortable, breathable, deodorant, close-fitting design, comfortable to wear, can effectively protect all parts of the wearer's head during training competitions, and improve the performance of players. It is a professional protective helmet for training and competition



per pc

Code	Size	Color	MRP.
XP2467	S,M,L,XL	White	2350.00

**CODE XP2003**

## TAEKWONDO GLOVES

- Made out of High quality PU Elastic construction
- Custom fit
- Sweat absorption
- Breathable and elastic hollow palm design



per pair

Code	Size	Color	MRP.
XP2003	S,M,L,XL	White	1100.00

**CODE XP2005**

## TAEKWONDO FOOT PROTECTOR

- Made out of High quality PU Elastic construction
- Custom fit
- Sweat absorption



per pair

Code	Size	Color	MRP.
XP2005	S,M,L,XL	White	1200.00

**CODE XP 2476**  
**BASIC CHEST GUARD**

- Material: PVC
- Made up of durable material
- Protects your chest against kick and punch
- Reversible Basic chest guard



per pc

Code	Size	Color	MRP.
XP2476	S,M,L	Blue/Red	1200.00



**CODE XP2006**  
**TAEKWONDO CHEST GUARD**

- Made out of High quality PU Elastic construction
- Reversible



per pc

Code	Size	Color	MRP.
XP2006	S/M, L/XL	White/Red	2000.00



**CODE XP2007**  
**ARM GUARD**

- Made out of PU construction
- Light weight allows a player playing with more speed.
- 3 elastic bands & velcro straps ensures the body fit of this arm guards.
- These straps are easy adjustable according to your comfort.



**INJECTION MOULD FOAM**

per pair

Code	Size	Color	MRP.
XP2007	S/M, L/XL	White	1150.00



**CODE XP2008**  
**TKD SHIN GUARD**

- Made out of PU construction
- Soft and comfortable to wear.
- Protect knees and legs
- Used for taekwondo, boxing, mma, muay thai, karate, martial arts, etc.



per pair

Code	Size	Color	MRP.
XP2008	S/M, L/XL	White	1200.00





**CODE XP1810**  
**WAKO T-20 PU GLOVES**

- Made out of High quality PU.
- Injection moulded inner foam
- Non Slip soft Inner Lining



per pair

Code	Size	Color	MRP.
XP1810	8,10,12,14,16oz	Red/Black Blue/Black	2200.00

**CODE XP1811**  
**WAKO T-20 PU HEADGUARD**

- Made out of High quality PU.
- Layered foam padding
- Non Slip soft Inner Lining



per pc

Code	Size	Color	MRP.
XP1811	S/M, L/XL	Red,Blue	1900.00



**CODE XP1807**  
**FOOT GUARD**

- Made out of High quality PU.
- Adjustable, elastic and reinforced straps on bottom
- Provides a great gripping on floors
- Better airflow keeps your Feet Dry, less sweaty and comfortable



per pair

Code	Size	Color	MRP.
XP1807	XS,S,M,L,XL	Red, Blue	1900.00





**CODE XP1812**  
**WAKO T-20 PU PROFESSIONAL SHINGUARD WITH FOOT**

- Made out of High quality PU.
- Hand moulded inner foam
- Non Slip soft Inner Lining



per pair

Code	Size	Color	MRP.
XP1812	S,M,L,XL	Red,Blue	2500.00



**CODE XP1813**  
**WAKO T/20 PU SHINGUARD WITHOUT FOOT**

- Made out of High quality PU.
- Hand moulded inner foam
- Non Slip soft Inner Lining



per pair

Code	Size	Color	MRP.
XP1813	S,M,L,XL	Red,Blue	1400.00





**CODE XP2101**  
**BOXING GLOVE**

- Made out of High quality PU.
- Injection Moulded Inner padding
- Lace up closure
- Durable & lightweight



per pair

Code	Size	Color	MRP.
XP2101	8oz, 12oz	Red,Blue	2100.00

**CODE XP2102**  
**WUSHU HEADGUARD**

- Made out of High quality PU.
- Adjustable back & top closure
- Comes with chin strap
- Durable & lightweight



per pc

Code	Size	Color	MRP.
XP2102	S/M, L/XL	Red,Blue	2300.00



**CODE XP2103**  
**WUSHU CHEST GUARD**

- Made out of High quality PU.
- Thick Adjustable straps
- Moisture wicking inner lining
- Lightweight



per pc

Code	Size	Color	MRP.
XP2103	STD	Red,Blue	2000.00



**CODE XP2104**  
**WUSHU SHORT VEST**

- Polyester bright mesh fabric.
- Shrink-resistant. Complete breathable.
- Full elasticated waist for a comfortable fit.
- Air ventilated fabric with moisture-absorbing ability.
- Provide you flexibility and comfort while practising.
- 150 GSM apx.

per set

Code	Size	Color	MRP.
XP2104	24 to 42	Blue, Red	1100.00



**CODE XP2105**  
**WUSHU KIT**

- A PAIR OF WUSHU BOXING GLOVE
- A PC OF WUSHU HEADGUARD
- A PC OF WUSHU CHEST GUARD



per set

Code	SET	Color	MRP.
XP2105	1 SET	Red,Blue	6200.00







CODE XP701

MMA SHORTS SUBLIMATED

- Polyester elastance woven/polyester
- Elastane knit
- Moisture-Wicking Properties for Comfort.
- Reinforced Stitching for Added Durability.
- Elastic Waistband for a Secure Fit.
- Stylish Sublimated Graphics for a Unique Look.



per pc

Code	Size	Color	MRP.
XP701	S,M,L,XL & XXL	Black/Red Black/Orange Black/HexGreen	2400.00



CODE XP702

MMA SHORTS

- Polyester elastance woven/polyester
- Elastane knit
- Moisture-Wicking Properties for Comfort.
- Reinforced Stitching for Added Durability.
- Elastic Waistband for a Secure Fit.



per pc

Code	Size	Color	MRP.
XP702	S,M,L,XL & XXL	Black/Red Black/Grey	1450.00



**CODE XP703**  
**COMPRESSION SHORTS**

- Polyester elastance knit
- Provides Targeted Muscle Support and Compression.
- Moisture-Wicking Material Keeps You Dry During Workouts.
- Elastic Waistband for a Secure and Snug Fit.



per pc

Code	Size	Color	MRP.
XP703	S,M,L,XL & XXL	Black/Orange Black/HexGreen	1300.00



**CODE XP704**  
**COMPRESSION SHORTS**

- Polyester elastance knit
- Provides Targeted Muscle Support and Compression.
- Moisture-Wicking Material Keeps You Dry During Workouts.
- Elastic Waistband for a Secure and Snug Fit.



per pc

Code	Size	Color	MRP.
XP704	M,L,XL & XXL	Black/Red	1100.00



**CODE XP729**  
**TIGHT SHORTS**

- Polyester elastance knit
- Designed for a Contoured and Form-Fitting Look.
- Offers Excellent Stretch and Flexibility for Movement.
- Moisture-Wicking Fabric to Keep You Dry and Comfortable.
- Elastic Waistband for a Secure and Comfortable Fit.
- Ideal for Yoga, Running, or Any Active Lifestyle.



per pc

Code	Size	Color	MRP.
XP729	S,M,L,XL & XXL	Black	1200.00



**CODE XP705**  
**COMPRESSION LOWER MENS**

- Polyester elastance knit
- Moisture-Wicking Material Keeps You Dry During Workouts.
- Elastic Waistband for a Secure Fit.
- Ideal for a Wide Range of Athletic Activities



per pc

Code	Size	Color	MRP.
XP705	S,M,L,XL & XXL	Black/Orange Black/HexGreen	2200.00



**CODE XP706**  
**COMPRESSION LOWER MENS**

- Polyester elastance knit
- Moisture-Wicking Material
- Elastic Waistband for a Secure Fit.
- Ideal for a Wide Range of Athletic Activities



per pc

Code	Size	Color	MRP.
XP706	S,M,L,XL & XXL	Black/Grey	1450.00



**CODE XP707**

**RASH GUARD SUBLIMATION LONG SLEEVE**

- Polyester elastance woven/polyester elastane knit
- Rash Guard Sublimation Long Sleeve
- Combination of Durable Woven and Flexible Knit Materials.
- Moisture-Wicking Properties Keep You Comfortable.
- Sublimated Graphics for Unique and Vibrant Designs.
- Long Sleeves for Extra Coverage and UV Protection.



per pc

Code	Size	Color	MRP.
XP707	M,L,XL & XXL	Black/Red Black/HexGreen	2400/-



**CODE XP708**

**RASH GUARD SUBLIMATION SHORT SLEEVE**

- Polyester elastance woven/polyester elastane knit
- Combination of Durable Woven and Flexible Knit Materials.
- Moisture-Wicking Properties Keep You Comfortable.
- Sublimated Graphics for Unique and Vibrant Designs.
- Short Sleeves Provide Freedom of Movement.



per pc

Code	Size	Color	MRP.
XP708	S,M,L,XL & XXL	Black/Red Black/HexGreen	1900/-



**CODE XP709**  
**RASH GUARD LONG SLEEVE**

- Polyester elastance woven/polyester elastane knit
- Flexible Fabric for Enhanced Comfort and Movement.
- Moisture-Wicking Material Keeps You Dry.
- Long Sleeves Offer Extra Coverage and Sun Protection.
- Available in Various Sizes for a Tailored Fit.

			per pc
Code	Size	Color	MRP.
XP709	M,L,XL & XXL	Black/Red	1700.00



**CODE XP710**  
**RASH GUARD SHORT SLEEVE**

- Polyester elastance woven/polyester elastane knit
- Flexible Fabric for Enhanced Comfort and Movement.
- Moisture-Wicking Material Keeps You Dry.
- Short Sleeves Provide Freedom of Movement.
- Available in Various Sizes for a Tailored Fit.

			per pc
Code	Size	Color	MRP.
XP710	M,L,XL & XXL	Black/Red	1400.00



**CODE XP711**  
**MEN'S WEIGHTLIFTING SUIT**

- Polyester/Spandex knit
- Dry fit
- Gripper elastic at thigh
- Special woven fabric at thigh
- Offers Excellent Stretch and Flexibility for Lifts.
- Moisture-Wicking Material
- Ideal for Weightlifting and Powerlifting Workouts



per pc

Code	Size	Color	MRP.
XP711	XS,S,M,L,XL & XXL	Blue/Black Red/Black	1550.00



**CODE XP712**  
**MEN'S WRESTLING SUIT**

- Polyester/Spandex knit
- Dry fit
- Gripper elastic at thigh
- Mesh vent under arm
- Moisture-Wicking Material
- Excellent Stretch and Flexibility for Quick Movements.
- Ideal for Competitive Wrestling and Training.



per pc

Code	Size	Color	MRP.
XP712	XS,S,M,L,XL & XXL	Blue/Black Red/Black	1550.00



**CODE XP713**  
**BOXING SHORTS & VEST KNITTED**

- 100% Polyester knit.
- Dry fit.
- Comfort in action.
- Ease of movement.
- Lightweight and Breathable for Boxing Training



per set

Code	Size	Color	MRP.
XP713	22" to 44" inch	Red/ White Blue/White	1100.00



**CODE XP715**  
**SAUNA SUIT HEAVY**

- 100% Polyester Woven Coated'
- Non Breathable
- Quick Dry
- Quick-Dry Properties
- Durable and Tear-Resistant
- Elastic Cuffs and Waistband for a Secure Fit.



per set

Code	Size	Color	MRP.
XP715	S,M,L,XL & XXL	Black/Red	3600.00



**CODE XP716**  
**BIBS**

- Material: Striped Mesh Fabric
- Lightweight Soccer Scrimmage Vests for Easy Movement.
- Breathable Design Keeps Players Comfortable.
- Available in Various Sizes for Teams of All Ages.
- Easily Identifiable Team Colours for Quick Team Differentiation.



per pc

Code	Size	Color	MRP.
XP716	JUNIOR/SENIOR	MULTI-COLOR	280.00



**CODE XP730**  
**BOXING SHORT SATIN**

- 100% Polyester Satin
- Dry fit
- Comfort in action
- Durable and Lightweight
- Elastic Waistband



per pc

Code	Size	Color	MRP.
XP730	S,M,L,XL	Black/White Red/White Blue/White	1400.00



**CODE XP731**  
**MUAY THAI SHORT**

- Crafted from Polyester Satin Weave Fabric.
- Secure and Comfortable Fit
- Drawstring Closure
- Above knee length
- Elastic Waistband



per pc

Code	Size	Color	MRP.
XP731	S,M,L,XL	Red/White Blue/White	1450.00



**CODE XP725**  
**WOMEN WEIGHTLIFTING SUIT**

- Polyester/Spandex knit
- Dry fit
- Tight fit
- Stretch fabric



per pc

Code	Size	Color	MRP.
XP725	XS,S,M,L,XL,XXL	Black/Red Black/Blue	1550.00



**CODE XP726**  
**WOMEN WRESTLING SUIT**

- Polyester/Spandex knit
- Dry fit
- Gripper elastic at thigh
- Comfort in action



per pc

Code	Size	Color	MRP.
XP726	XS,S,M,L,XL	Black/Red Black/Blue	1550.00



# FITNESS CLOTHING





**CODE XP732**  
**TRAINING T-SHIRT**

- Comfortable and breathable fabric for all day wear.
- Classic fit that flatters all body types.
- Durable constructions for long lasting quality.
- Easy to care.

			per pc
Code	Size	Color	MRP.
XP732	S,M,L,XL,XXL	Airforce Blue	800.00

COLOURS AVAILABLE



**CODE XP733**  
**BOXER T-SHIRT**

- Comfortable and breathable fabric for all day wear.
- Classic fit that flatters all body types.
- Durable constructions for long lasting quality.
- Easy to care.

			per pc
Code	Size	Color	MRP.
XP733	S,M,L,XL,XXL	Black	800.00

COLOURS AVAILABLE



**CODE XP734**  
**RUNNER T-SHIRT**

- Comfortable and breathable fabric for all day wear.
- Classic fit that flatters all body types.
- Durable constructions for long lasting quality.
- Easy to care.

			per pc
Code	Size	Color	MRP.
XP734	S,M,L,XL,XXL	Neon Green	800.00

COLOURS AVAILABLE



95



**CODE XP735**  
**BOUT T-SHIRT**

- Comfortable and breathable fabric for all day wear.
- Classic fit that flatters all body types.
- Durable constructions for long lasting quality.
- Easy to care.

			per pc
Code	Size	Color	MRP.
XP735	S,M,L,XL,XXL	White	800.00

COLOURS AVAILABLE



**CODE XP736**  
**X-CLASSIC POLO T-SHIRT**

- Comfortable and breathable fabric for all day wear.
- Classic fit that flatters all body types.
- Durable constructions for long lasting quality.
- Easy to care.

			per pc
Code	Size	Color	MRP.
XP736	S,M,L,XL,XXL	Light Grey, Navy Blue, Pistachio	850.00

COLOURS AVAILABLE



**CODE XP737**  
**X-MELANGE T-SHIRT**

- Comfortable and breathable fabric for all day wear.
- Classic fit that flatters all body types.
- Durable constructions for long lasting quality.
- Easy to care.

			per pc
Code	Size	Color	MRP.
XP737	S,M,L,XL,XXL	Air force blue, Silver	1000.00

COLOURS AVAILABLE



**CODE XP738**  
**X-LITE FIT T-SHIRT**

- Comfortable and breathable fabric for all day wear.
- Classic fit that flatters all body types.
- Durable constructions for long lasting quality.
- Easy to care.

Code	Size	Color	MRP.	per pc
XP738	S,M,L,XL,XXL	White/ Grey, Blue	1000.00	

COLOURS AVAILABLE



**CODE XP739**  
**X-TRAINER T-SHIRT**

- Comfortable and breathable fabric for all day wear.
- Classic fit that flatters all body types.
- Durable constructions for long lasting quality.
- Easy to care.

Code	Size	Color	MRP.	per pc
XP739	S,M,L,XL,XXL	Black, White, Airfoce Blue Army Green	1100.00	

COLOURS AVAILABLE



97



**CODE XP741**  
**X-MELANGE T-SHIRT**

- Comfortable and breathable fabric for all day wear.
- Classic fit that flatters all body types.
- Durable constructions for long lasting quality.
- Easy to care.

			per pc
Code	Size	Color	MRP.
XP741	S,M,L,XL,XXL	Air force blue, Silver	1000.00

COLOURS AVAILABLE



**CODE XP742**  
**X-LITE FIT T-SHIRT**

- Comfortable and breathable fabric for all day wear.
- Classic fit that flatters all body types.
- Durable constructions for long lasting quality.
- Easy to care.

			per pc
Code	Size	Color	MRP.
XP742	S,M,L,XL,XXL	White/ Grey, Blue	1000.00

COLOURS AVAILABLE



**CODE XP743**  
**X-TRAINER T-SHIRT**

- Comfortable and breathable fabric for all day wear.
- Classic fit that flatters all body types.
- Durable constructions for long lasting quality.
- Easy to care.

			per pc
Code	Size	Color	MRP.
XP743	S,M,L,XL,XXL	Black, White, Airfoce Blue Army Green	1100.00

COLOURS AVAILABLE







## SKIPPING ROPE RANGE

**XP801**  
**WEIGHTED SKIPPING ROPE**  
**WITH ALUMINUM HANDLE**  
**MRP. 1100.00** per pc



**XP 802**  
**CABLE JUMP ROPE**  
**MRP. 600.00** per pc



**XP 803**  
**COTTON ROPE WITH**  
**PLASTIC HANDLES**  
**MRP. 170.00** per pc



**XP 804**  
**NYLON SPEED ROPE STEEL WIRE**  
**PLASTIC FOAM GRIP HANDLES**  
**MRP.380.00** per pc



**XP 805**  
**PVC JUMP ROPE**  
**MRP. 600.00** per pc



**XP 806**  
**STRIKER JUMP ROPE**  
**MRP.850.00** per pc



**XP 807**  
**BASIC NYLON SKIPPING ROPE**  
**MRP.120.00** per pc



**XP 808**  
**LEATHER SKIPPING ROPE**  
**WITH WOODEN HANDLES**  
**MRP.650.00** per pc



**XP 809**  
**LEATHER SKIPPING ROPE**  
**WITH ALUMINUM HANDLES**  
**MRP 1000.00** per pc





**XPEED**<sup>®</sup>  
CRAFTED FOR CHAMPION



**CODE XP1235**  
**SOFT PLYO BOX**

- Durable PVC construction for long-lasting performance.
- Soft surface for impact absorption and reduced risk of injuries.
- Non-slip surface for a secure and stable workout platform.
- Versatile tool for plyometric training, box jumps, and step-ups.
- The PVC material is resistant to moisture and sweat, making it effortless to clean after each workout.



per pc

Code	Size in INCH	Color	MRP.
XP1235	6"	Black/Yellow	2400.00
	12"	Black/Green	4000.00
	18"	Black/Red	5800.00
	24"	Black/Blue	7300.00



**CODE XP1237**  
**SLIDING DISC**

- Helps build core stability
- Soft foam provides firm grip
- PACK OF 4
- Compact and lightweight construction
- The dual-surface design offers versatility for use on various floor type



per pc

Code	Sets	Color	MRP.
XP1237	Pack of 4	Black/Yellow	850.00



**CODE XP1238**  
**WOODEN PLYO BOX**

- Made of nylon coated material 580 gsm.
- Box Jumps are a great way to work on your explosiveness
- Run faster and Jump higher by performing box jumps regularly
- Increase your speed with explosive jumping ability in a few short weeks
- Increase your strength and balance

per pc

Code	Size in INCH	Color	MRP.
XP1238	50x60x75	Black	18,000.00







**CODE XP909**  
**EXERCISE WHEEL**

- Easy-Grip Wheels and two Non-Skid wheels for added Stability.
- Dual wheel offers more stability, control and balance

per pc			
Code	Size in cm	Color	MRP.
XP909	18cm wheel dia 25cm handle length	Black/Blue	850.00



**CODE XP2444**  
**EXERCISE WHEEL**

- Available sizes. 180x30x3.8 cm
- Strength and coordination workout of your entire body through climbing movements
- Can put multiple boards side by side to create desired climbing lengths
- Two dowel peg handles included
- Mounting accessories included

per pc			
Code	Size in cm	Color	MRP.
XP2444	STD	Black/Red	2150.00



**CODE XP910**  
**BALANCE BOARD**

VERSATILE, COMPACT BALANCE BOARD: With the lightweight, portable design, this balance board is great for Balance Exercises, Home Gyms, Gyms, Sport Performance Enhancement, Physiotherapy, Rehabilitation, Strength and Balance Workouts

per pc			
Code	Size in cm	Color	MRP.
XP910	STD	Black	1750.00



**CODE XP911**  
**SUSPENSION TRAINER SET**

- Complete Functional Training.
- Heavy duty anchor and loop design.
- Premium webbing and barrel lock adjusters.
- Sturdy handles and foot cradles.

per set			
Code	Size in cm	Color	MRP.
XP911	STD	Olive	3600.00





# RESISTANCE BANDS & TUBES



**CODE XP912**  
**TONING TUBE**

Made out of natural Rubber You can use the resistance tube with handles to train your upper body including your legs, chest, shoulders, abs, arms and back with a number of resistance tube exercises such as Resistance bicep Curls, bent-over row, chest press, squats, hamstring curls and push-ups,etc



per pc

Code	Size	Color	MRP.
XP912	LIGHT	Orange	550.00
	MEDIUM	Blue	600.00
	HEAVY	Green	650.00

**CODE XP913**  
**SUPER BAND**

- Made of highly stretchy and durable material.
- Easy pull up band with full stretch for complete body stretch and fitness workout.
- Easy to use



per pc

Code	Size in mm	Color	MRP.
XP913	2 x 15 mm	Yellow	650.00
	3 x 20 mm	Red	1000.00
	4.8 x 25 mm	Red	2250.00
	4.8 x 45 mm	Blue	2300.00

**CODE XP914**  
**MINI BAND**

- (Light, Medium, Heavy, Super Heavy and Extra Super Heavy)
- Suitable for beginners & advance users.
  - Extremely flexible & durable bands made with the best stretch raw material.
  - Increase strength and stability in the upper and lower body by using these versatile Mini Bands.



per set

Code	Size	Color	MRP.
XP914	LIGHT	Green	700.00
	MEDIUM	Blue	
	HEAVY	Yellow	
	SUPER HEAVY	Red	
	EXTRA SUPER HEAVY	Black	

**CODE XP915**  
**CHEST EXPANDER**

Its light weight makes it easy for your take it traveling everywhere like office, camping and exercise anytime for chest developer.

Non slip handles, assemble & disassemble the tubes according to needs



			per pc
Code	Size	Color	MRP.
XP915	STD	Orange	650.00

**CODE XP916**  
**EXPANDER TUBE SET**

- Provides Comfort Grip with Adjustable Straps
- For Upper and Lower Body Workout, Improves Flexibility, Strength and Stamina.
- Durable Straps



			per set
Code	Size	Color	MRP.
XP916	STD	Red, Blue, Green	1850.00

**CODE XP1203**  
**TPE BAND**

- One of the key advantages of TPE bands over traditional rubber resistance bands is their durability and resistance to wear and tear.
- TPE bands are also more environmentally friendly, as they can be recycled and reused.



			per pc
Code	Size	Color	MRP.
XP1203	MEDIUM	Green	420.00
	STRONG	Blue	450.00

**CODE XP1213**  
**RESISTANCE STRAP**

- Polypropylene (PP) and rubber
- Helps to lengthen upper and lower body
- Helps to increase flexibility and hold stretched poses
- Versatile functions

per pc			
Code	Size in CM	Color	MRP.
XP1213	S (80cm)	Green/Black	500.00
	M (90cm)		550.00
	L (115cm)		600.00



**CODE XP918**  
**YOGA CORK BRICK**

- Durability: Xpeed Cork brick is a strong and durable material that can withstand heavy use and foot traffic.
- It is resistant to water, fire, and insects, making it a low-maintenance option for sports facilities.
- Non slip & sweat resistance surface

per pc			
Code	Size in cm	Color	MRP.
XP918	23x12.7x7.6cm	Light Brown	1100.00



**CODE XP1702**  
**YOGA LOOP**

- Yoga loop
- Band width: 38MM
- Helps to strengthen muscles and stabilise core
- Useful for improving technique
- Polypropylene (PP) and rubber

per pc			
Code	Size	Color	MRP.
XP1702	STD	Grey	250.00



**CODE XP2483**  
**YOGA RING**

- Yoga rings are commonly used in yoga, Pilates, and other fitness classes to provide resistance for various exercises.
- They can be used to target specific muscle groups, such as the arms, chest, thighs, and core.
- Comfortable secure and Non-slip grip

per pc			
Code	Size	Color	MRP.
XP2483	STD	Turquoise/Grey	2200.00



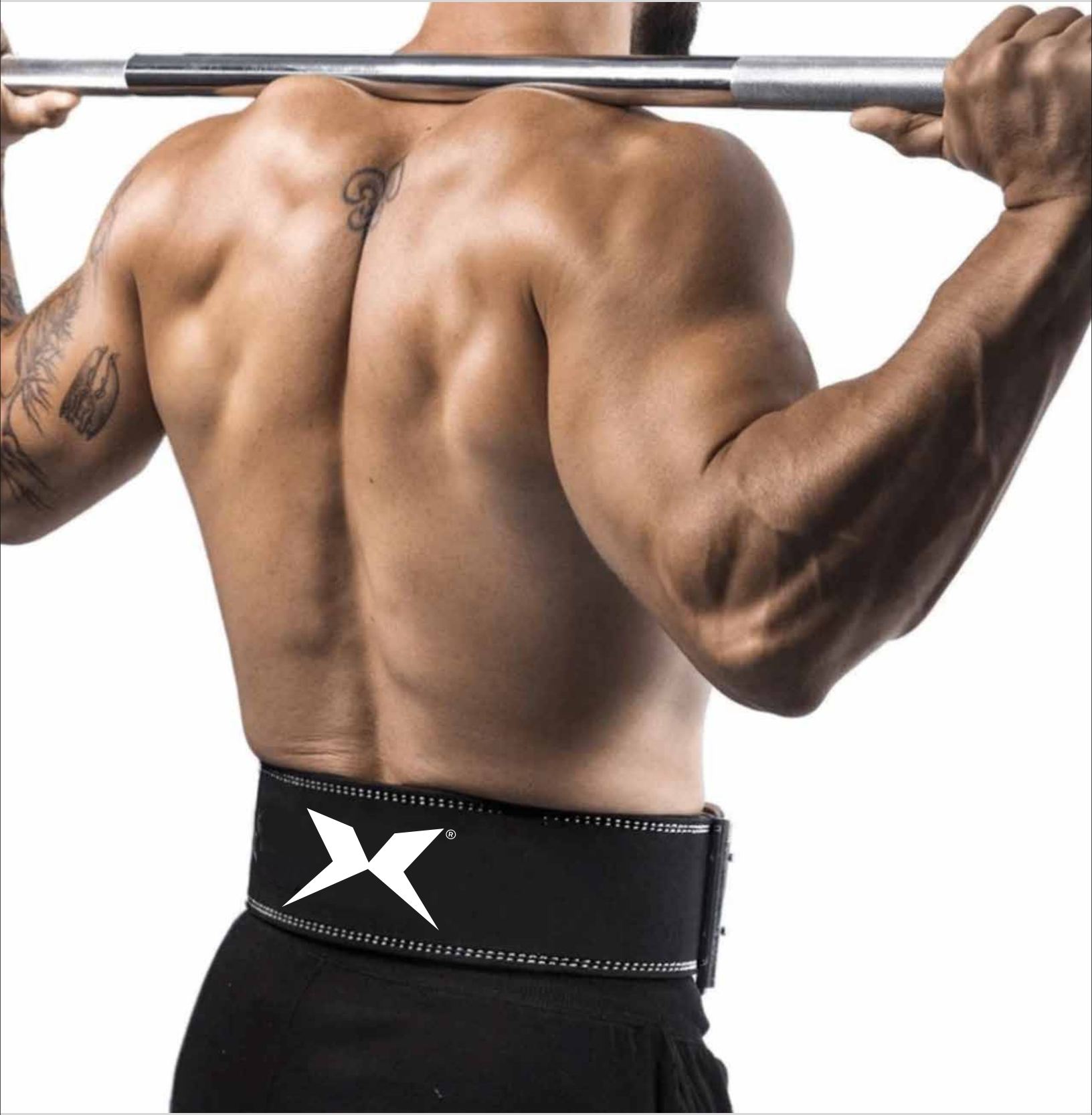



**CODE XP1001**

**ALL LEATHER POWER LIFTING BELT**

- Suede leather & metal construction
- Layered leather construction.
- Dual stitched heavy duty nylon thread.
- Double pronged zinc plated steel buckle.



per pc

Code	Size	Color	MRP.
XP1001	S, M, L, XL	Black	1700.00



**CODE XP1003**  
**DIP BELT**

- Made out of split leather
- Durable & long lasting
- Adjustable chain length
- Comfortable & secure fit



per pc

Code	Size	Color	MRP.
XP1003	STD	Black	1700.00



**CODE XP1004**

**ALL LEATHER WEIGHT LIFTING BELT 6"**  
**PREMIUM VEG-TAN**

- Premium veg-tan leather construction
- 6 inch width for optimal core & lower back support
- Reinforced stitched for enhanced durability during heavy lifting
- Provides superior support & stability



per pc

Code	Size	Color	MRP.
XP1004	S, M, L, XL	Brown	1700.00





## CODE XP1005 ALL LEATHER WEIGHT LIFTING BELT 4" PREMIUM VEG-TAN

- Made out of split leather
- Padded in back for cushioning
- More durable and stiffer
- Easy to open & close



per pc

Code	Size	Color	MRP.
XP1005	S, M, L, XL	Black	1550.00



## CODE XP1006 ALL NYLON WEIGHTLIFTING BELT 6 INCH CAMO

- Made out of nylon material
- More durable and stiffer
- Easy to open & close
- Supported by Heavy Duty, Stainless Steel Slide Bar Buckle,

per pc

Code	Size	Color	MRP.
XP1006	S,M,L,XL	Camo	1100.00



## CODE XP1007 GYM NYLON PADDED LIFTING BELT

- 6" INCH WIDE Made of High Quality Neoprene with Strong Nylon Cloth Closure System.
- High Quality Velcro Closure provides snug fit, Velcro fastener Very comfort.
- Light in weight, Strong Stitching and Comfortable Long Lasting Weightlifting training.

per pc

Code	Size	Color	MRP.
XP1007	S,M,L,XL	Black	1100.00



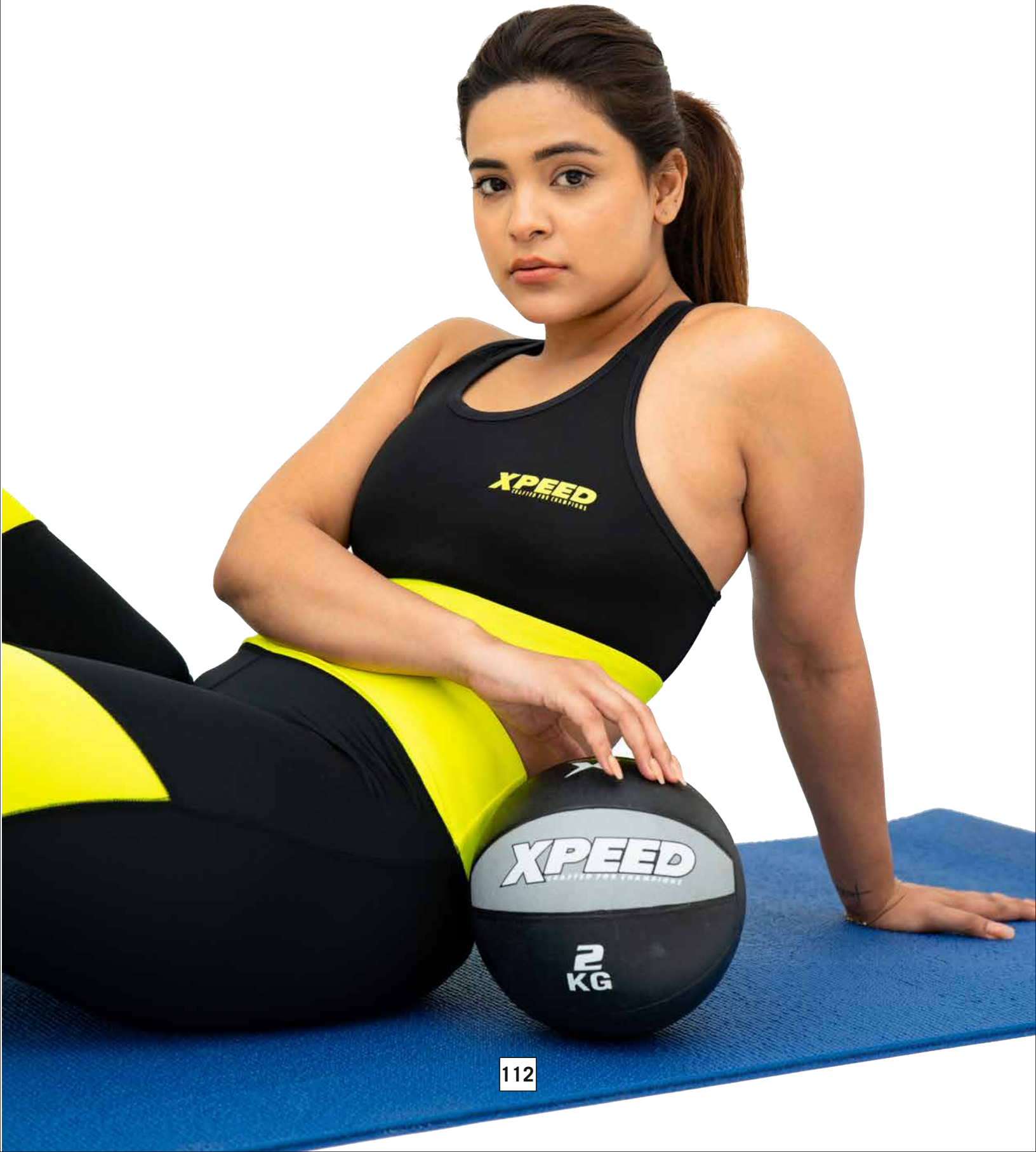



**CODE XP1101**  
**MOULDED MEDICINE BALL**

- Made Rubber With Textured Surface.
- Weighted With Rubber & Air.
- Sturdy and durable.
- Improve your coordination and balance



Code	Size in KG	Color	MRP.
XP1101	1kg	Black/Purple	1150.00
	2kg	Black/Grey	1300.00
	3kg	Black/Red	1750.00
	4kg	Black/Green	2150.00
	5kg	Black/Blue	2400.00
	6kg	Black/Orange	2650.00
	7kg	Black/Yellow	3100.00
	8kg	Black/Purple	3350.00
	9kg	Black/Yellow	3700.00
	10kg	Black/Maroon	3850.00



**XP 1102**  
**SLAM BALL**

- Strong rubber construction
- Ideal for slamming exercise
- Non-slip rubber surface



Code	Size in KG	Color	MRP.
XP1102	4kg	Black	1250.00
	6kg	Red	1500.00
	8kg	Maroon	1900.00
	10kg	Black	2200.00
	12kg	Red	2400.00
	15kg	Maroon	3350.00



**XP 1103**  
**LEATHER MEDICINE BALL**

- Made out of high quality Leather.
- Compact size is perfect for all your workouts.
- Improve coordination and balance.
- Medicine ball workouts can train up the cardiovascular system.



Code	Size in KG	Color	MRP.
XP1103	1kg	Black/Red	550.00
	2kg		800.00
	3kg		1100.00
	4kg		1450.00
	5kg		1800.00
	6kg		1900.00
	7kg		2300.00
	8kg		2600.00
	9kg		2950.00
	10kg		3250.00



**CODE XP1106  
WALL BALL**

- Precision nylon thread seam construction with a moisture and scuff-resistant coated-vinyl shell.
- The interior filling is substantial enough to help the ball keep its shape across repeated use.
- Wall Balls are a must for all crossfit training & core development.



per pc

Code	Size in KG	Color	MRP.
XP1106	4kg	Multicolor	1850.00
	6kg		2000.00
	8kg		2450.00
	10kg		3200.00
	12kg		3800.00



**CODE XP1204**  
**CORE BAG**

- Crafted from high quality PU
- Multiple handles that provide diverse exercises to target each muscle.
- Provide diverse angles for more workout moves: Lunges, Deadlift, Squat, Burpee, Snatch, Spider, Overhead press, Hammer curl, Crossfit and mo



per pc

Code	Size in KG	Color	MRP.
XP1204	5kg	Black/Blue	1850.00
	10kg	Black/Orange	2450.00
	15kg	Black/Red	2750.00
	20kg	Black/Green	3100.00
	25kg	Black/Grey	3650.00



**XP 1234**  
**BULGARIAN BAG**

- Heavy coated fabric construction Bulgarian Bags/Banana Bag (weighted bag)
- Nylon Strap handles with secured stitching
- Must for strength training
- Enhances core and grip strength
- Available in different weight options



per pc

Code	Size in KG	Color	MRP.
XP1234	5kg	Black/Blue	2800.00
	10kg	Black/Red	4300.00
	15kg	Black/Green	5500.00
	20kg	Black/Yellow	6700.00







## CODE XP1201-SMALL ROG STEP AEROBIC

- Like other forms of exercise, step aerobics helps burn calories and fat.
- The number of calories burned depends on the speed of movements, step height, length of exercise, and the persons height and weight.
- Durable plastic construction
- Non-slip surface

			per pc
Code	Size	Color	MRP.
XP1201	SMALL	Black/Orange	2100.00



## CODE XP1201-BIG ROG STEP AEROBIC

- Like other forms of exercise, step aerobics helps burn calories and fat.
- The number of calories burned depends on the speed of movements, step height, length of exercise, and the persons height and weight.
- Durable plastic construction
- Non-slip surface

			per pc
Code	Size	Color	MRP.
XP1201	BIG	Black/Green	3300.00



## CODE XP2445 AEROBIC STEP

- Plastic construction
- Use as a stepper in bench
- Bench adjustable at 30 degree, 45degree & 70degree angles
- Storage for a small fitness accessories
- Height adjustable for stepper
- Textured surface for grip

			per pc
Code	Size	Color	MRP.
XP2445	Adjustable	Black/Grey	19,200.00



**CODE XP2480**  
**AEROBIC STEP**

- PP Material construction
- Textured surface grip
- Adjustable Height in 3 steps  
12cm, 17cm, 22cm

per pc

Code	Size in CM	Color	MRP.
XP2480	72x27x12cm	Blue/Grey	3100.00



**CODE XP2481**  
**AEROBIC STEPPER PRO**

- Durable plastic construction
- Adjustable height in 3 step  
15cm, 20cm, 25cm
- Non-slip top surface
- Rubber surface for grip.

per pc

Code	Size in CM	Color	MRP.
XP2481	97x37x15cm	Orange/Grey	8650.00



**CODE XP2482**  
**BOSU BALL**

- Using a Bosu ball in your workout routine can provide several benefits, including improved balance, coordination, and core strength.
- The unstable surface of the ball challenges your body to engage additional muscles to maintain balance and stability.
- The toning tube and card buckle design guarantee safety of exercising

per pc

Code	Size	Color	MRP.
XP2482	STD	Black/Orange	10,550.00



**CODE XP1202  
SAND BELL**

- Neoprene construction
- Soft feel
- Self sand filling

per pc

Code	Size in Kg	Color	MRP.
XP1202	2kg	Black/Orange	1050.00
	4kg	Black/Yellow	1200.00
	6kg	Black/Green	1800.00
	8kg	Black/Purple	1950.00



**CODE XP1226  
PU AB PAD**

- Crafted from premium polyurethane
- Contoured shape provides excellent support and comfort
- The PU cover is slip-resistant for stability during exercises
- Features a dual-layer foam design for optimal cushioning
- Suitable for a wide range of abdominal and core exercises

per pc

Code	Size	Color	MRP.
XP1226	STD	BLACK	950.00



**CODE XP917  
GYMNASTIC RING**

- Xpeed Gymnastic Ring Perfect for CrossFit and strength training.
- Wood construction, Adjustable straps
- Easy to grip and gentle on your hands
- Easy to install

per pc

Code	Size	Color	MRP.
XP917	STD	Orange	2500.00

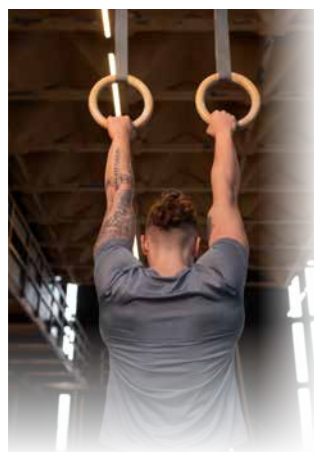

**CODE XP920  
DOOR BAR 80 CM**

It is a horizontal bar that is typically mounted on a doorframe or wall, and it is used for exercises that target the upper body, particularly the back, arms, and shoulders.

per pc

Code	Size in cm	Color	MRP.
XP920	80 cm	Orange/Black	1450.00



**CODE XP2446**  
**BALANCE CUSHION WITH PUMP**

- Thermoplastic construction with Acupressure points  
Builds core strength
- Helpful in multiple postures like standing, sitting, squatting, lying down etc.
- Ideal for rehabilitation.
- Helps kids with poor balance & weak core.

per pc

Code	Size in cm	Color	MRP.
XP2446	33cm	Purple, Orange, Green	1200.00



**CODE XP1205**  
**MASSAGE ROLLER**

- Travel-sized foam massage roller with 96 flexible bumps for muscle penetration
- Bumps knead body contours to stretching soft tissue (muscle and fascia)
- Erodes trigger points, restores flexibility and brings relief from muscle pain
- Control the amount of pressure applied by adjusting your body position

per pc

Code	Size in inch	Color	MRP.
XP1205	13"	Black	1450.00
	18"		2150.00



**CODE XP1206**  
**GYM BALL**

- Use it for yoga, pilates, stretching and more!
- Keep your entire body engaged: Upper Body, Back, Abs Core, Legs and Pelvic Floor Muscles!
- Manufactured from burst resistant, Used durable PVC, it's perfect for tough workouts. Made of high-quality rubber for durability.
- Our yoga/gym balls are perfect for everyday use, tough workouts and exercise.

per pc

Code	Size in cm	Color	MRP.
XP1206	65cm	Orange	1200.00
	75cm	Grey	1450.00
	85cm	Blue	1600.00
	95cm	Pink	2300.00



**CODE XP919**  
**ELASTICATED LIFTING WRIST WRAP**

- Heavy duty woven elasticised cotton wrap for maximum support
- Assists lifting confidence and performance

per pair

Code	Size in cm	Color	MRP.
XP919	49x8cm	Black/Red Black/Blue Black/Yellow Black/Green	400.00



**CODE XP1207**  
**POWER PRO LIFTING STRAP**

- Easy use design to support lifting exercises
- Helps reduce hand and finger fatigue
- Padded edges reduces strap burn and increase grip
- Simple adjustable design one size fits all

			per pair
Code	Size in cm	Color	MRP.
XP1207	49x5 cm	Black	350.00



**CODE XP1208**  
**ELASTICATED LIFTING WRIST WRAP**

- Heavy duty woven elasticised cotton wrap for maximum support
- Assists lifting confidence and performance

			per pair
Code	Size in cm	Color	MRP.
XP1208	45.5x7.5cm	Black/Orange	600.00



**CODE XP1209**  
**ELASTICATED ELBOW WRAP**

- Anatomically contoured shape for better fit, grip and easy movement
- Four way stretchable material provides intermittent massaging action during movements
- Additional hook and loop strap for extra support

			per pair
Code	Size in cm	Color	MRP.
XP1209	75x8 cm	Black/Orange	850.00



**CODE XP1241**  
**COTTON LIFTING WRAP**

- Strong cotton construction
- Padded back of hand patch
- Ideal for weight lifting power lifter dead lift strengthen training workout.

			per pair
Code	Size in cm	Color	MRP.
XP1241	53 cm	Black	350.00



**CODE XP1211**  
**FIGURE 8 LIFTING STRAP**

- Made from premium cotton
- Provides comfortable support to your wrist
- Easy use design to support lifting exercises
- Extra wide neoprene padding for maximum comfort
- Easy use loop design locks bar in place for lifting confidence

			per pair
Code	Size in inch	Color	MRP.
XP1211	STD	Black	500.00



**CODE XP1212**  
**ELASTICATED KNEE WRAP**

- 80 inch long x 3 inch wide
- Heavy Duty woven elasticized cotton wrap for maximum support
- Easy fastening and adjustment with hook and loop closure
- Assists Knee support and stability through a range of motion
- Assists lifting confidence and performance

			per pair
Code	Size in cm	Color	MRP.
XP1212	203 x 7.5cm	Black/Orange	1100.00



**CODE XP2484**  
**METAL HANDGRIP**  
**CAPACITY 100 KG**

- Solid aluminum handles with non slip grip
- Great for enhancing hand and finger grip strength
- Rust-Proof coated spring in different resistance level for all levels of users
- Xpeed Metal handgrip designed to be comfortable to wear and allow for maximum flexibility and movement while still providing protection and grip.

			per pc
Code	Size in inch	Color	MRP.
XP2484	STD	Multi colour	950.00



**CODE XP2485**  
**METAL HANDGRIP**  
**CAPACITY 150 KG**

- Solid aluminum handles with non slip grip
- Great for enhancing hand and finger grip strength
- Rust-Proof coated spring in different resistance level for all levels of users
- Xpeed Metal handgrip designed to be comfortable to wear and allow for maximum flexibility and movement while still providing protection and grip.

			per pc
Code	Size in inch	Color	MRP.
XP2485	STD	Multi colour	1100.00







**CODE XP1214  
VINYL KETTLE BELL**

- These Kettlebell is a cast-iron or cast steel & Vinyl-coated
- Non-slip handles.
- Precision balanced weight distribution for smoother movements
- Color-coded for easy weight identification

per pc			
Code	Size in CM	Color	MRP.
XP1214	4KG	MULTICOLOR	1440.00
	8KG		2880.00
	10KG		3600.00
	12KG		4320.00
	16KG		5760.00
	20KG		7200.00
	24KG		8640.00
	28KG		10,080.00



**CODE XP1215  
COMPETITION KETTLE BELL**

- These Kettlebell is a cast-iron or cast steel
- Smooth, Non-slip handles.
- Precision balanced weight distribution for smoother movements
- Color-coded for easy weight identification

per pc			
Code	Size in CM	Color	MRP.
XP1215	4KG	GREY	5000.00
	6KG	BLACK	5200.00
	8KG	PINK	5500.00
	12KG	BLUE	5600.00
	16KG	YELLOW	7800.00
	20KG	PURPLE	9400.00
	24KG	GREEN	11,200.00
	28KG	ORANGE	13,200.00
	32KG	RED	15,300.00



**CODE XP1216  
PLASTIC KETTLE BELL**

- Durable Plastic construction
- Compact and Lightweight
- Comfortable, Non-slip handles
- Build strength, endurance, and overall fitness.

per pc			
Code	Size in CM	Color	MRP.
XP1216	3KG	PINK	1450.00
	5KG	YELLOW	1650.00
	8KG	GREEN	2350.00
	12KG	BLACK	2950.00



**CODE XP1217**  
**AB SLING**

- Heavy Duty nylon construction
- EVA padded with soft fabric lining
- Reinforced stitching
- Adjustable strap length

Code	Size	Color	MRP.
XP1217	STD	BLACK	2050.00



**CODE XP1218**  
**ANKLE WEIGHT (PER PAIR)**

- Durable Nylon construction with durable stitched
- Comfortable, adjustable straps
- Filled with iron pellets for even weight distribution
- Non-Slip and ergonomic

Code	Size in CM	Color	MRP.
XP1218	0.5KG	BLACK	600.00
	1KG		850.00
	1.5KG		950.00
	2KG		1100.00
	2.5KG		1300.00
	3KG		1600.00



**CODE XP1219**  
**POWER PRO LIFTING HOOK (PER PAIR)**

- Single piece heavy duty, 2 1/2 inch wide metal hook
- Deluxe 1/4 inch thick, 2 1/2 inch wide neoprene
- Single piece die cast HD stainless steel buckle
- Heavy duty oversized webbing reinforces wrist section
- Hook and loops closure for easy adjustment and secure fit

Code	Size	Color	MRP.
XP1219	STD	BLACK	1050.00



**CODE XP1220  
WEIGHTED VEST**

- Fully adjustable, one size fits all up to 125 cm chest
- Contoured design with centralized weight placement to reduce core imbalance when training
- Simple weight management with slide in pockets
- Single piece die cast HD stainless steel buckles
- Hook and loop closure for easy fit and adjustment
- Available in multiple weight configuration

per pc

Code	Size in KG	Color	MRP.
XP1220	5KG	BLACK	3300.00
	10KG		4000.00
	15KG		5050.00
	20KG		5750.00



**CODE XP1221  
BATTLE ROPE**

- Premium Nylon construction
- Heat shrink handles
- Non-slip grip for comfortable and secure workouts
- Rope Thickness: 25mm Rope

per pc

Code	Size in FT.	Color	MRP.
XP1221	30FT	BLACK	6600.00
	50FT		9850.00



**CODE XP1222  
PULLY JUMP ROPE**

- Thick jute rope
- Metal Hook with bolts
- Easy to install and fix
- Ideal for both indoor and outdoor climbing and strength training

per pc

Code	Size in FT.	Color	MRP.
XP1222	15 ft	Beige	3850.00



**CODE XP1223**  
**ARM BLASTER**

- Heavy-duty frame for durability and stability.
- Ergonomic design for comfortable arm isolation.
- Adjustable strap for a secure and custom fit.
- Rust-resistant coating for long-lasting use.
- Compact and portable
- Ideal for bicep and tricep isolation

			per pc
Code	Size in CM	Color	MRP.
XP1223	57x9cm	BLACK	1750.00



**CODE XP1224**  
**USED TYRE**

- High-quality rubber compound for durability.
- Reinforced internal structure for stability
- Eco-friendly option, promoting tire recycling
- Perfect for a wide range of exercises, including tire slams, tire flips, and sledgehammer swings, to target different muscle groups.

			per pc
Code	Size in KG	Color	MRP.
XP1224	50kg	BLACK	6600.00
	70kg		9000.00
	100kg		10,800.00



**CODE XP1225**  
**HAMMER**

- Made from durable steel for lasting exercise use
- Ergonomic handle for a secure hold
- Powder-coated finish for durability
- Improves balance and coordination



			per pc
Code	Size in KG	Color	MRP.
XP1225	4kg	BLACK	3550.00
	6kg		3800.00
	10kg		5600.00



**CODE XP1701**  
**HEAD HARNESS**

- Designed for controlled neck strengthening exercises
- Heavy duty webbing for maximum strength
- Hook and loop closure for easy adjustment and secure fit
- ¼ inch thick, extra wide neoprene padding for maximum comfort
- Chin strap for extra hardness stability
- Heavy duty D shackles ensures strong connection point for weight chain
- Forehead D shackle for greater exercise scope
- Chain length 75 cm

			per pc
Code	Size	Color	MRP.
XP1701	STD	Black	1200.00







# RUBBER HEX DUMBBELLS

## CODE XP1227 DUMBBELL

- Dumbbells are coated with PVC for durability and comfort
- Secure and non-slip grip
- Suitable for both strength and aerobic workouts
- Available in various colors for quick and easy weight identification

per pc			
Code	Size in KG	Color	MRP.
XP1227	0.50kg	Multi-colour	200.00
	1kg		360.00
	1.50kg		550.00
	2kg		700.00
	3kg		1000.00
	4kg		1370.00
	5kg		1700.00



## CODE XP1228 HEXA DUMBBELLS

- Constructed with a sturdy cast iron core for durability
- Knurled handles offer a secure and comfortable grip
- Hex design prevents rolling and ensures stability
- Clear weight indicators for easy identification.



per pc			
Code	Size in KG	Color	MRP.
XP1228	2.5kg	Black	1320.00
	5kg		2650.00
	7.5kg		3960.00
	10kg		5280.00
	12.5kg		6600.00
	15kg		7920.00
	20kg		10,560.00
	25kg		13,200.00



## CODE XP1229 HAND GRIP

- Soft foam on the handles
- EVA Padded belt for back support while exercising
- Ergonomically designed for maximum support
- Extra wide at the back to maximise support while lifting heavy weights
- Foam Padded handles, easy and convenient to use
- Durable spring system and lightweight

per pair	
Code	MRP.
XP1229	450.00



## CODE XP1230 ADJUSTABLE HANDGRIP

- Spring made from stainless steel
- Non-slip handles
- Give extra grip and comfort while exercise
- Useful In Forearm/wrist Workout
- Easy adjust the resistance from 10kg to 40kg

per pc	
Code	MRP.
XP1230	520.00



**XP 1231  
BARBELL PAD BACK**

- Constructed with a high-density foam core for cushioning and support
- Features a durable nylon cover for long-lasting use
- Secure Velcro closure for easy installation
- Designed to fit most standard barbells and Olympic bar

Code	Size in CM	Color	MRP.
XP1231	42x3 cm	BLACK	800.00

per pc



**XP 1232  
PUSH UP BAR**

- Constructed with a durable PU for long-lasting use.
- Ergonomic handles for a comfortable and secure grip.
- Lightweight and easy to carry for on-the-go exercise
- Suitable for use on a variety of flooring types

Code	Size	Color	MRP.
XP1232	STD	BLACK/SILVER	800.00

per pair



**XP 1233  
SHAKER**

- BlenderBall Whisk Inside
- Odor-Resistant Eastman Tritan Plastic
- Stay Open Flip Cap Won't Close on your Nose
- Rubberized Sport Grip Offers a Firm Grip
- Ounce and Milliliter Markings for Easy Measuring
- Large Drink/Pour Spout
- Easy to Clean—Dishwasher Safe
- BPA-Free

Code	Product No	Color	MRP.
XP1233	1046	BLACK/ORANGE	270.00
	1047	BLACK	430.00

per pc



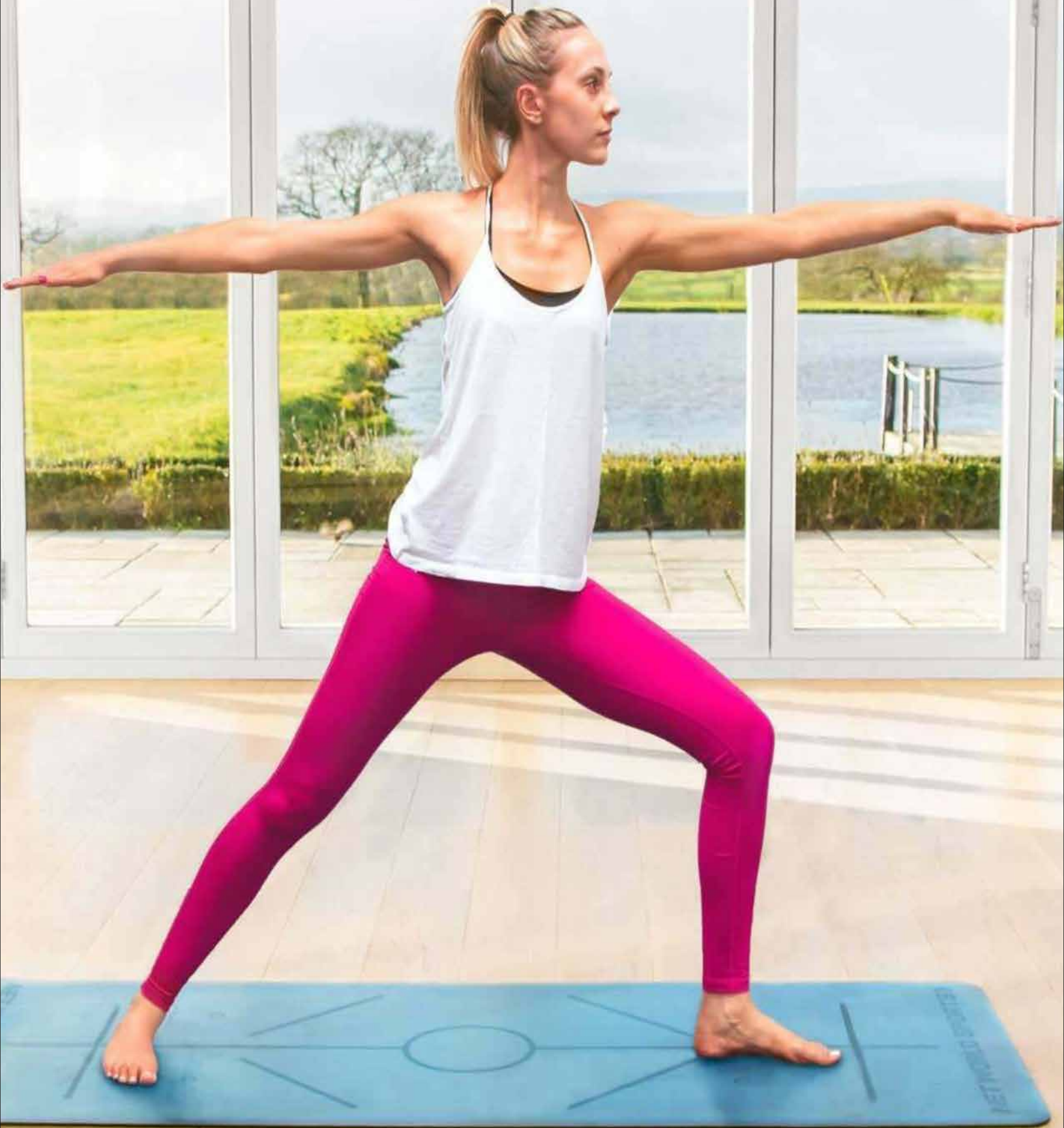



**CODE XP1301**  
**TRI FOLD MAT**

- Made out of high quality nevatear PVC
- The non-slip bottom keeps the mat in place during exercises
- Equipped with integrated carry handles for convenient portability
- Folds into three sections for easy storage and transport
- Provides a comfortable surface for floor exercises and stretches

per pc

Code	Size in Inch	Color	MRP.
XP1301	180cm x 90cm x 50mm 6ft. x 3ft. x 2 inch	BLACK	3800.00



**CODE XP1302**  
**YOGA MAT**

- The non-slip bottom keeps the mat in place during exercises
- Equipped with integrated carry handles for convenient portability
- Rolls up for easy storage and transportation
- Provides a comfortable surface for floor exercises and stretches

per pc

Code	Size in cm	Color	MRP.
XP1302	173x90cm 68x35.5inch	BLACK	2650.00



**CODE XP1303**  
**NYLON MAT**

- Made from durable nylon for long-lasting use
- Provides a non-slip grip for stability during exercises
- Folds up for easy storage and transportation
- Moisture-Resistant

per pc

Code	Size in Inch	Color	MRP.
XP1303	180cm x 75cm x 28mm 6ft. x 2.5ft. x 1 inch	BLACK	2900.00



**CODE XP1304**  
**TPE YOGA MAT**

- Made from TPE a non-toxic and eco-friendly material.
- Dual-color design with a textured surface for enhanced grip and stability.
- Lightweight and portable.
- Suitable for various types of yoga, Pilates, and other floor exercises.
- Durable and long-lasting.
- Rolls up for easy storage and transportation

per pc

Code	Size in MM	Color	MRP.
XP1304	181x61x0.6 (6 MM)	Orange/Grey	1650.00
	181x61x0.8 (8 MM)	Blue/Grey	2000.00
	181x61x10 (10 MM)	Green/Grey	2100.00



**CODE XP1305**  
**RUBBER TILES**

- Made from tough rubber materials for long-lasting performance.
- Provides shock absorption to protect floors and reduce noise
- Easy-to-install for quick setup.
- Slip-resistant surface ensures safety during workouts
- Simple to clean and maintain for hygiene



Code	Size in Inch	Color	MRP.
XP1305	20 x 20 inch	Multicolour	180.00 Sq. ft.

per pc

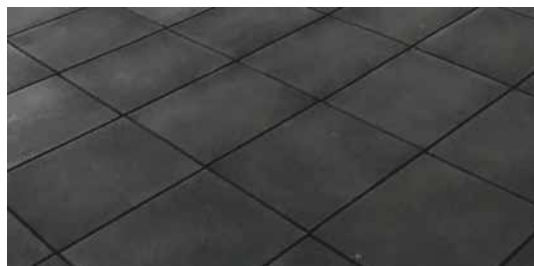

**CODE XP1307**  
**INTERLOCK MATT**

- Made from high-quality EVA foam for durability and comfort
- Easy-to-assemble puzzle-like pieces for quick installation.
- Free from harmful chemicals, making it safe for all ages
- Non-Slip Surface
- Resists moisture and is easy to clean and maintain
- 106 square cm



Code	Size in MM	Color	MRP.
XP1307	20 mm	Blue, Red	2150.00
	25mm		2750.00
	40mm		4800.00
	50mm		8200.00

per pc

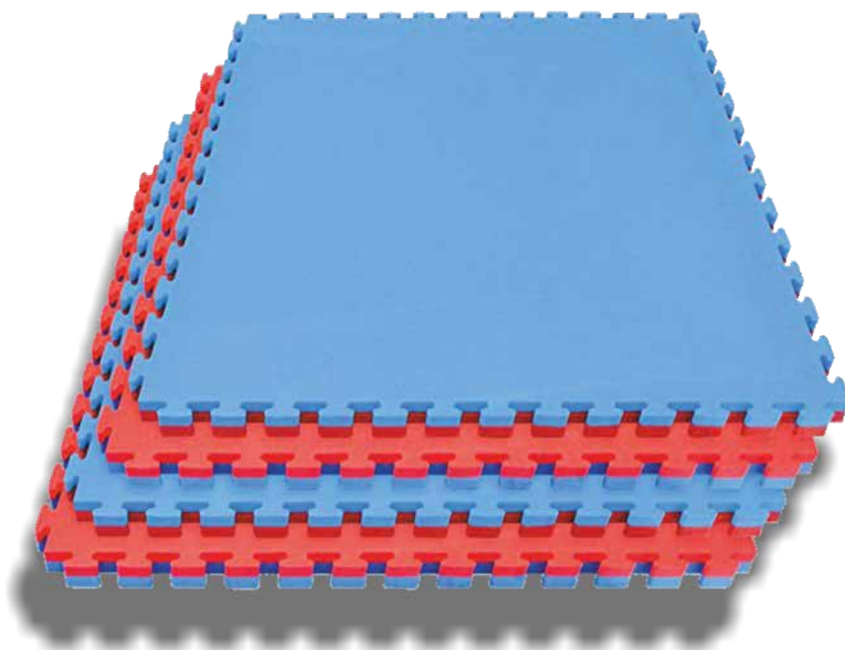





**XP 901  
FUSION WEIGHTLIFTING GLOVES**

- Microsuede top hand panelling for strength and performance.
- Silicon embossed palm
- Contoured anatomical design with neoprene wrist cuff and velcro closure
- Compact and portable gym accessory

per pair

Code	Size	Color	MRP.
XP901	S/M L/XL	Black/Red Black/Blue Black/Yellow	1050.00



**XP 902  
WOMEN WEIGHTLIFTING GLOVES**

- Microsuede top hand panelling for strength and performance.
- Silicon embossed palm
- Tailored to fit women's hands comfortably
- Adjustable for a secure Velcro closure
- Enhanced Grip and Control

per pair

Code	Size	Color	MRP.
XP902	S/M L/XL	Black/Green, Black/Red	900.00



WEIGHT LIFTING  
FITNESS  
TRAINING  
BODY BUILDING  
GYM

**XP 903**  
**NUCLEAR WEIGHTLIFTING GLOVES**

- Mesh on back for Ventilation
- Microsuede top hand panelling for strength and performance.
- Contoured anatomical design with neoprene wrist cuff and velcro closure
- Breathable and Sweat-Wicking per pair

Code	Size	Color	MRP.
XP903	S/M L/XL	Black/Red Black/Blue	900.00



**XP 904**  
**INVADER WEIGHTLIFTING GLOVES**

- Mesh on back for Ventilation
- Contoured anatomical design with elasticated wrist cuff and velcro closure
- Breathable and Sweat-Wicking per pair

Code	Size	Color	MRP.
XP904	S/M L/XL	Black/Red Black/Blue	930.00



**XP 905  
RIDE WEIGHTLIFTING GLOVES**

- Microsuede top hand panelling for strength and performance.
- Silicon embossed palm
- Mesh on back Ventilation
- Breathable and Sweat-Wicking

per pair

Code	Size	Color	MRP.
XP905	S/M L/XL	BLUE/GREEN/GREY	930.00



**XP 906  
AIR VENT GLOVES**

- Made of durable synthetic Leather
- Stretchable Lycra backhand for extra comfort
- Pull off tabs for easy removal
- Breathable and Sweat-Wicking

per pair

Code	Size	Color	MRP.
XP906	S/M L/XL	GREY/RED, GREY/YELLOW	600.00







## CODE XP2401 GYM ROD

- High-Quality Steel Construction
- textured grip for a secure and comfortable hold
- Comes in various lengths, allowing for versatile exercise options
- Designed to handle substantial weight loads

Code	Size	per pc MRP.
XP2401	OB 47	7800.00
	OB 60	8500.00
	OB72	10,800.00
	OB 86	14,200.00

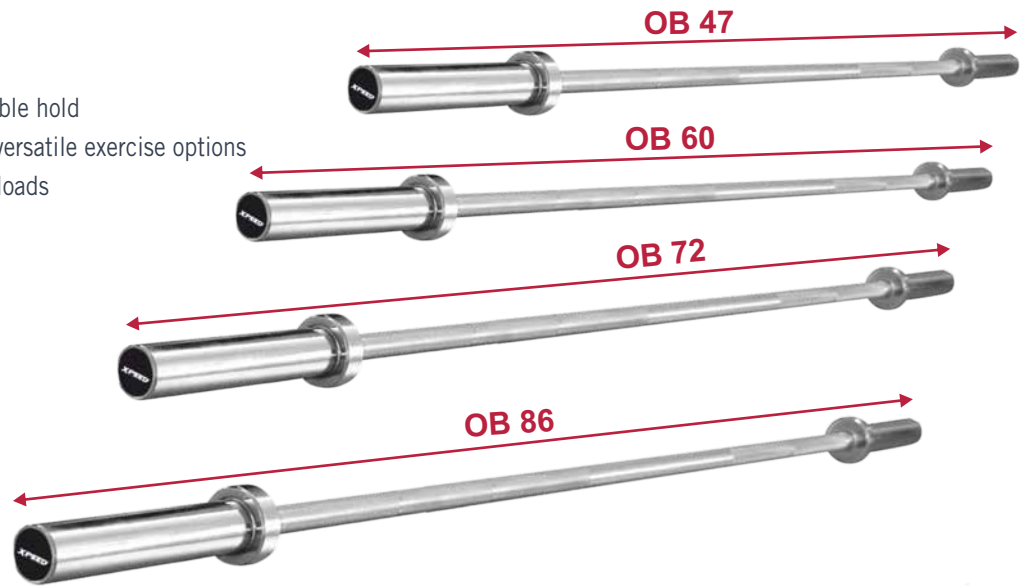

## CODE XP2402 GYM ROD

- Crafted from robust and long-lasting steel
- Secure and comfortable grip
- Designed to handle substantial weight loads
- Ideal for various strength-training exercises

Code	Size	per pc MRP.
XP2402	4 NB 86	22,800.00
	6 NB 86	25,200.00

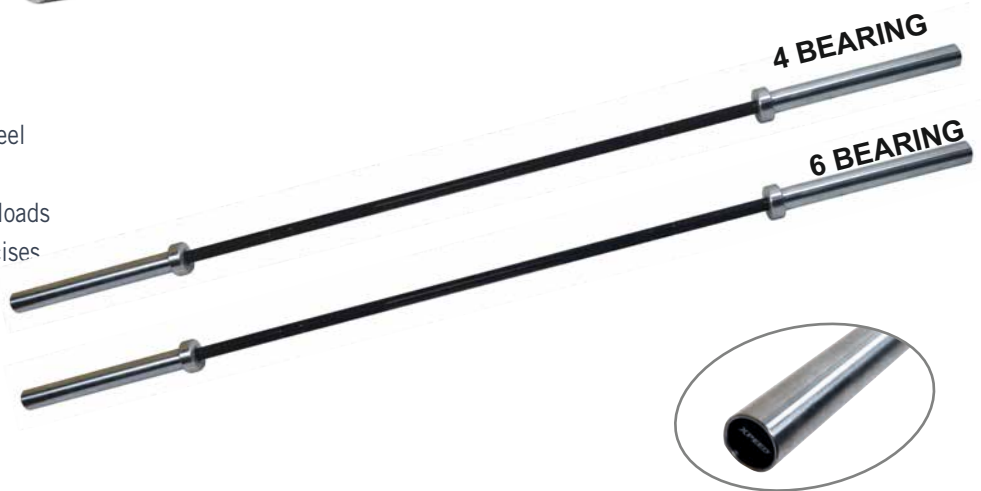

## CODE XP2403 GYM ROD

- Durable Steel Construction
- Ergonomic Curl Design
- Designed to fit standard or Olympic weight plates
- Secure and Comfortable grip
- Ideal for various strength-training exercises

Code	Size	per pc MRP.
XP2403	OB 47	8900.00



### CODE XP2435

#### CERAKOTE MEN BAR

- This ceramic and polymer coating specifically enhances a number of physical performance properties including abrasion/wear resistance, corrosion resistance, chemical resistance, impact strength, and hardness.
- After making the tests, Cerakote is seventy times better than chrome and even a hundred times better than black zinc.
- Considering that this ceramic coating is used by various military organizations around the world, we are convinced that it will perform its work with excellence also on our barbells.
- Size 42 cremo alloy steel 2.2 mm handle diameter 28mm, 20 kgs.



per pc	
Code	MRP.
XP2435	28,800.00

### CODE XP2436

#### CERAKOTE WOMEN BAR ROD

- This ceramic and polymer coating specifically enhances a number of physical performance properties including abrasion/wear resistance, corrosion resistance, chemical resistance, impact strength, and hardness.
- After making the tests, Cerakote is seventy times better than chrome and even a hundred times better than black zinc.
- Considering that this ceramic coating is used by various military organizations around the world, we are convinced that it will perform its work with excellence also on our barbells.
- Size 42 cremo alloy steel 2.01 mm handle diameter 25mm, 15 kgs.



per pc	
Code	MRP.
XP2436	26,400.00

### CODE XP2437

#### CERAKOTE CAMOUFLAGE MEN BAR

- 42CrMo alloy steel construction, 6 needle bearings, Brass bushing.
- Hard chromed handle bars and sleeves, 750 kg. Loading weight, Tested for 2000 drops, Fine knurling.
- 28 mm diameter, 2.2 mm handle Camo print, Ceramic coated for enhanced durability & corrosion resistance.
- Camo print.

per pc	
Code	MRP.
XP2437	36,000.00



**CODE XP2405  
PARALLETTES**

- Solid Metal Construction
- Fits easily in smaller workout spaces
- Easy Assembly
- Enhances balance, stability, and core strength



per set

Code	MRP.
XP2405	5300.00



**CODE XP2406  
EQUALIZER BAR**

- Crafted from durable Metal
- Comfortable foam handles for secure grips
- Easy Assembly
- Portable and Lightweight



per set

Code	MRP.
XP2406	7500.00



**CODE XP2407  
WALL PULL UP SYSTEM**

- Made of heavy-duty Metal.
- Non-slip grips and padded back and armrests,
- One-piece solid construction ensures stability and durability
- Perfect for exercising your backs, shoulder, chest, arms, triceps, biceps, lats, and the front of your abs.



per set

Code	Size	MRP.
XP2407	LIGHT	4800.00
	HEAVY	5400.00



**CODE XP2408  
CHIN UP BAR**

- Crafted from durable Metal
- Ultra-strong for strenuous workouts.
- A rigid solid precision engineered for easy home installation
- Allows you to perform pull ups easily and safely.

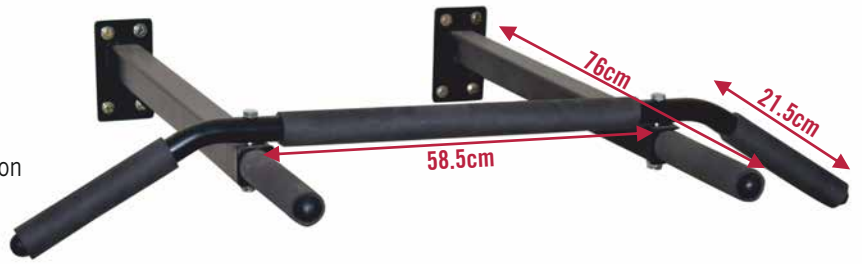

per set

Code	MRP.
XP2408	2500.00

**CODE XP2409  
CHALK**

- Keeps hands sweat free.
- Contains 8 pcs (2oz,each)per pack.
- Gym chalk is made of a superior magnesium carbonate formula which promotes a firm & reliable grip.
- Keep your hands dry without caking on contact.



per set

Code	Pack of	MRP.
XP2409	8 pcs	1800.00

**CODE XP2413  
BARBELL COLLER**

- Engineered Nylon plastic construction
- Cam clamp system to secure on barbell
- Easy on and off
- Ideal for olympic barbell 50 mm Rod
- Color : Black



per set

Code	MRP.
XP2413	1200.00

**CODE XP2410**  
**DEAD LIFT BAR**

Dual handle design on hex bar for easy controlled lifting to target desired muscle groups while reducing risk of injury. Perfect for squats, deadlifts, shrugs, power pulls and more. Hexagonal frame design keeps your Olympic weights centered during heavy lifting, engaging the quads instead of the lower back.

		per pc
Code	Size	MRP.
XP2410	STD	17,800.00

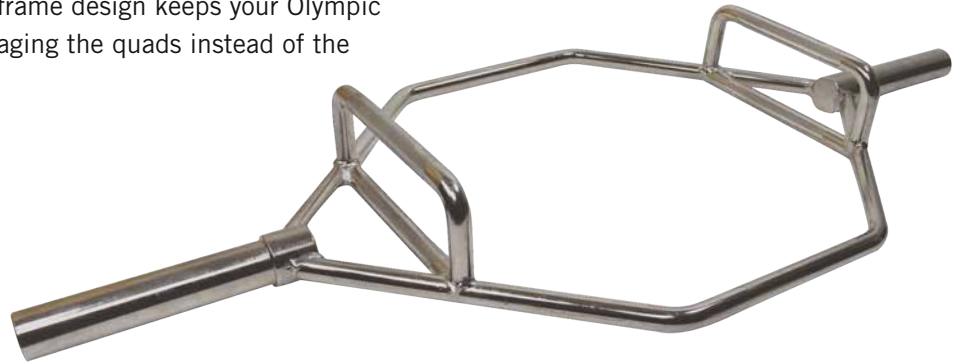

**CODE XP2411**  
**BUMPER PLATES (WITHOUT HUB)**

Bumper Plates are the answer for competition bumper plates at the right price. A Durometer rating of 90 hits the sweet spot for minimal bounce and maximum durability. The plates stand up to high reps and intense workouts. The narrow plate thickness allows room for multiple plates per side.

		per prs
Code	Size	MRP.
XP2411	5 KG	4500.00
	10KG	9000.00
	15KG	13,450.00
	20KG	18,000.00
	25KG	20,000.00



**CODE XP2412**  
**COMPETITION BUMPER PLATES (WITH HUB)**

Olympic Bumper Plates are the answer for competition bumper plates at the right price. A Durometer rating of 90 hits the sweet spot for minimal bounce and maximum durability. The plates stand up to high reps and intense workouts. The narrow plate thickness allows room for multiple plates per side. The 50.6mm opening and reinforced steel collar make for a secure fit

		per prs
Code	Size	MRP.
XP2412	5 KG	8400.00
	10KG	13,200.00
	15KG	19,200.00
	20KG	25,200.00
	25KG	31,200.00



**CODE XP2426**

**DEAD LIFT PLATFORM FULL SET**

- Metal Rubber and Wood Construction.
- 40mm Thickness.
- Pegs for tying lates loop bands.
- S' holder for bolting the ground.

**Specification**

Colour Name : Multicolour

Included Components : 1 Pc Deadlift platform metal fram, 1 Pc Wood plank for deadlift-platform & Rubber tiles for side 13 pcs



Code	Size	per prs MRP.
XP2426	131(L)x 246 (W) x 4 cm (H) 51.60 (L) x 97 (W) x 1.60 (H) INCH	66,000.00



**CODE XP2414**  
**DOUBLE DISPLAY STAND**

- Designed to Hold 10 Medicine/Wall Balls.
- Stores Balls in Upright Position.
- All Welded Using Quality Steel & Sturdy Construction.
- Ideal Space Saving Storage Solution.
- NO MEDICINE BALL INCLUDED

**Specification**

Material : Metal,  
Finish : Anti rust Powder coated & chrome plated  
Colour : Black  
Max. Load capacity : 250 kg.  
**\*Medicine Ball not included**

		per pc
Code	Size	MRP.
XP2414	(L) 52 X (B) 43 X (H) 176 CM 20.5 x 17 x 69.25 Inch	<b>8150.00</b>

**CODE XP2415**  
**GYM CHALK STAND**

- Can hold up to 5 pounds of chalk..
- Easily move from one end of your gym to another..
- Caster wheels lock to secure..
- Wide mouth bowl makes chalking up fast and easy.

Package Contents and Specifications :

- Contents: 1 - Rolling Chalk Stand (No Chalk Included)
- Weight: 28 pounds

**Specification**

Material : Metal  
Finish : Anti rust Powder coated & chrome plated  
Colour : Black  
Max. Load capacity : 250 kg.

		per pc
Code	Size	MRP.
XP2415	(L) 66 X (B) 66 X (H) 107 CM 26 x 26 x 42 Inch	<b>11,950.00</b>

**CODE XP2416**  
**BUMPER PLATE STACKER**

- Efficient: The Xpeed weight plates stacker is a mobile storage system for transporting weight plates with 50 mm attachments.
- Strong: thanks to its solid steel construction, this weight plate stand can hold up to 250 kg.
- Features: material: steel, powder coating, max. Load capacity: 250 kg | four floor castors | suitable for weight plates with 50 mm intake. Xpeed Weight Plates Stacker Specification

**Specification**

Material : Metal  
Finish : Anti rust powder coated  
Colour : Black  
Max. Load capacity : 250 kg.

**\*Bumper plates not included**

		per pc
Code	Size	MRP.
XP2416	(L) 62 X (B) 62 X (H) 108 CM 24.5 x 24.5 x 42.5 Inch	<b>10,550.00</b>



**CODE XP2417**  
**OLYMPIC WEIGHT PLATE TREE**

Limited on Space with messy Plates Around?  
 The Xpeed Vertical Plate Tree L72 is a Compact,  
 Efficient & Comfortable Plate storage Solution  
 for all the Olympic Weight Plates.

It features six 12 long storage posts that  
 collectively enable 72 Plate Loading Capacity.

**Specification**

Material : Metal

Finish : Anti rust powder coated

Colour : Black

Max. Load capacity : 250 kg.

**\*Bumper plates not included**



Code	Size	MRP.	per pc
XP2417	(L) 63 X (B) 81 X (H) 160 CM 25 x 32 x 63 Inch	16,550.00	

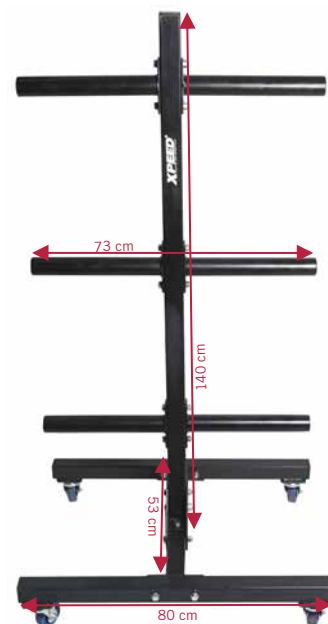

**CODE XP2418**  
**METAL PLYO BOX**

HEAVY DUTY CONSTRUCTION

Plyo boxes are made of Iron for maximum strength and durability. Plyometric box is covered by red powder coating, it is durable, restless, and scratch-proof.

6 SIZES PLYO BOXES

The jump box package includes 6,12",18",24" 30, 36 in height, allows you to perform numbers of exercise with no need to buy extra Plyo boxes. You may start with lower heights and increase them as you improve.

**Specification**

Material : Metal

Finish : Anti rust powder coated

Colour : Black



Code	Size	MRP.	per pc
XP2418	15 cm (6')	2000.00	
	30cm (12')	2550.00	
	45cm (18')	3400.00	
	60cm (24')	4450.00	
	75cm (30')	5300.00	
	90cm (36')	6050.00	

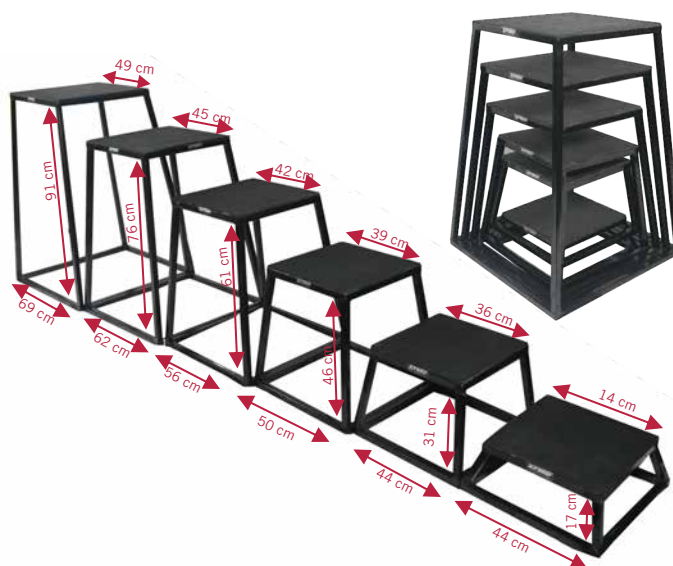

**CODE XP2419**  
**DUMBBELL RACK**

HEAVY-DUTY WELDED CONSTRUCTION – Keep all of your weights secure at all times with the Marcy Dumbbell Rack. Made from commercial-grade steel, its durable frame can stand heavy loads while resisting damage from intensive use over time.

**Specification**

Material : Metal

Finish : Anti rust powder coated

Colour : Black

**\*Dumbbell not included**



Code	Size	MRP.	per pc
XP2419	(L) 51 X (B) 109 X (H) 95 CM 20 x 43 x 37.5 Inch	11,100.00	



**CODE XP2420**  
**POWER BAG DISPLAY KIT**

- Make sure this fits by entering your model number.
- Heavy-Duty Construction – Steel Construction Comprised of 12- and 14- Gauge Steel Thickness Overhead Workout Station Is Made With High Grade Tubular Steel.
- Durable & Reliable – 3-Step Powder Coat Finish for Exceptional Durability; Gussets for Extra Reinforced Support; Capped Frame Ends to Prevent Oxidation.

**Specification**

Material : Metal  
 Finish : Anti rust powder coated  
 Colour : Black Textured  
 Max. Load capacity : 100kg./220Lbs

**\*Powerbag not included**

		per pc
Code	Size	MRP.
XP2420	(L) 42 X (B) 54 X (H) 174 CM 16.5 x 21 x 68.5 Inch	7200.00



**CODE XP2421**  
**BARBELL GUN RACK**

- Good quality
- Useful product
- Gun rack

**Specification**

Material : Mild steel & plastic construction  
 Finish : Anti rust powder coated  
 Colour : Black

**\*Rod not included**

		per set
Code	Size	MRP.
XP2421	(L) 5 X (B) 9 X (H) 45 CM 2 x 3.5 x 17.75 Inch	4450.00



**CODE XP2422**  
**PLATFORM SET**

Xpeed Punching bag stand with Speedball platform  
 This multifunctional boxing stand from Xpeed is ideal for home use.  
 You do not have to drill in the wall or ceiling and you can get started right away.

**Specification**

Material : Metal  
 Finish : Anti rust powder coated  
 Colour : Black  
 Max. Load capacity : 250 kg.

**\*Punchbag & Speedball not included**

		per pc
Code	Size	MRP.
XP2422	(L) 155 X (B) 109 X (H) 207 CM 61 x 43 x 81.5 Inch	33,600.00



## CODE XP2423

### BELT ROPE HANGER

A matter of convenience and for the sake of organizing your gym accessories. This product is a must have for any serious training facility. It can hold up to 60 jump ropes or 30-60 Latex loops (depending on the width) or 30 fitness belts. Mix them all up and you would still have a proper storage on a rack.

#### Specification

Material : Metal

Finish : Anti rust powder coated

Colour : Black

Max. Load capacity : Hold up to 60 jump ropes or 30-60 fitness belts.

		per pc
Code	Size	MRP.
XP2423	(L) 26 X (B) 61 X (H) 10 CM 10.25 x 24 x 4 Inch	6000.00



## CODE XP2424

### BENCH SET

#### Specification

Material : Metal

Finish : Anti rust powder coated

Colour : Black

Max. Load capacity : 250 kg.

		per pc
Code	Size	MRP.
XP2424	(L) 158 X (B) 75 X (H) 56 CM 62.25 x 29.5 x 22 Inch	23,400/-



## CODE XP2425

### SQUAT RACK

• Heavy Duty Squat Racks

• A great squat rack for both home gyms and commercial gyms. The Xpeed heavy-duty squat rack is compatible with all of our commercial attachments. ie, our spotter arm and dip bar attachments will both fit this rack perfectly.

• We built this rack at 210cm tall. The reason we did this is that we found a lot of home gym enthusiasts had ceilings considerably lower than most commercial quality squat racks at 230cm.

• Being a bit shorter allows this rack to fit into all home gym spaces that we know of.

#### Specification

Material : Metal

Finish : Anti rust powder coated

Colour : Black

Max. Load capacity : Hold up to 60 jump ropes or 30-60 fitness belts.

Size : (L) 120 X (W) 124 X (H) 200 CM

47.25 x 48.80 x 78.75 Inch

**\*Rod & Bumper plate not included**

		per pc
Code	Size	MRP.
XP2425	(L) 120 X (B) 124 X (H) 200 CM 47.25 x 48.80 x 78.75 Inch	45,600.00



**CODE XP4101**

**SQUAT STAND -INDEPENDENT PRO**

- Available in 2 x 2 Square Pipe – 11 Gauge.
- Assembled Size – (W)24 x (L)26 (base) x Height 6 Ft.
- Plate Horns Storage for more stability and plate storage.
- Includes J-Hooks and also Safety Spotter.
- Tough Signature Black Mat Powder Coat Finish.
- Hole Patern: 50 mm center to center.
- Added plate Horns @ base for weight storage and more stability.

RUST PROOF		per set
Code	Size	MRP.
XP4101	(W) 24 X (L)26 X (H) 6ft	25,200.00



**CODE XP4102**

**SQUAT STAND WITH PULL UP BAR**

- Available in 2 x 2 or 3 x 3 Square Pipe – 11 Gauge.
- Assembled Size – (W)48 x (L)48 (base) x Height 8 Ft.
- Pull Up Bar Adjustable on – 6 Ft / 7 Ft / 8 Ft.
- Westside Whole Spacing (1" through bench and clean pull zone, 2" spacing above).
- Includes J-Hooks and also Safety Spotter (20 ).
- Built-in weight horns (8 inches long) for rock-solid stability and plate storage.
- Color Availability – Tough Signature Black Mat Powder Coat Finish.

RUST PROOF		per pc
Code	Size	MRP.
XP4102	(W) 48 x (L) 48 x (H) 8ft	38,400.00

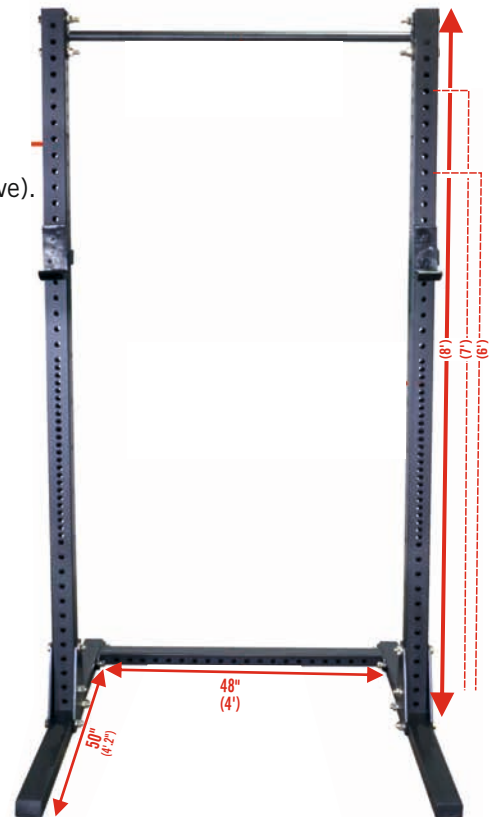

**CODE XP4103**  
**POWER RACK – TIGER**

- 11 Gauge 3" x 3" steel mainframe – With uprights Height of 90 .
- Dimensions : Width: 46 " x Length: 48 " x Height: 90 .
- Westside Hole Pattern – 1" through bench and clean pull zone then 2" spacing above and below.
- Unique 2 Pull-up bar's.
- Includes : (2) J-Cups, (2) Middle Pin/Solid Pipe Safety Spotter, (4) Band Pegs.
- Unit must be bolted to the floor.
- COLOR: Black Dull Mat Powder Coated Finish. Other Color also available as per buyer requirement
- Pull up is Adjustable from 6ft to 8 Ft.

		per pc
Code	Size	MRP.
XP4103	(W) 46 X (L) 48 X (H) 90"	68,400.00

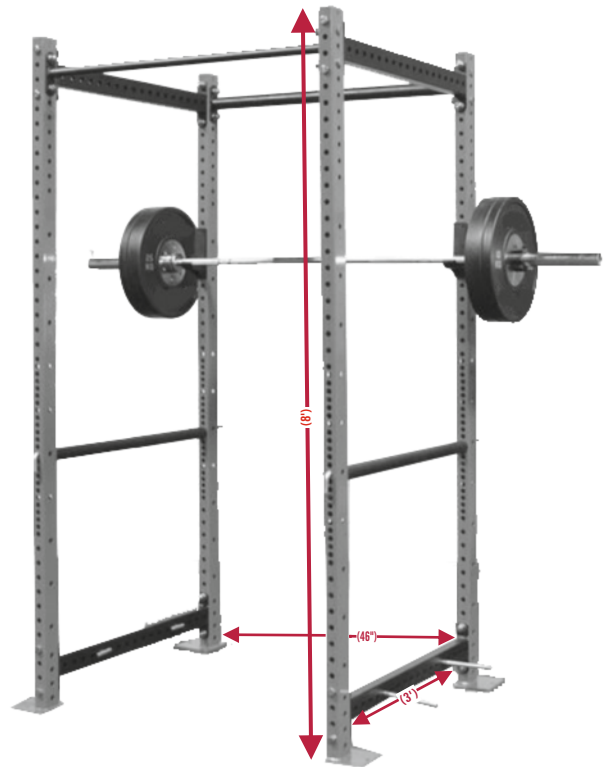

**CODE XP4104**  
**POWER RACK ECONOMY – 2.0**

- 2 x 2 or 3 x 3 heavy gauge steel construction.
- Dimensions: 47 (W) x 45.5 (L) x 86 (HEIGHT).
- Includes Pair Of J-CUP and Pipe & Pin safety spotters with locking lynch pins.
- Westside Whole Spacing Hole Pattern – 2" spacing from bench press to squat pins (2 Ft to 7 Ft).
- Monkey Cross multi-grip pullup station.
- Signature Black Mat Finish powder coated finish – Uprights. Not to be Bolted On Ground. easily Movable to other place.

		per pc
Code	Size	MRP.
XP4104	(W) 47 X (L) 45.5 X (H) 86	62,400.00



**CODE XP2432**  
**MACHINE ACCESSORIES**

- HIGH QUALITY STEEL WITH NEOPRENE COATING – Commercial grade Q235 structural steel coated with neoprene rubber for optimal grip and durability. Feels great in your hands. Thick and Heavy Built to last a long time!
- MULTI FUNCTION USE- Perfect for seated rows, standing rows, straight arm pulldown, etc. The V bar is a great cable machine attachment for close grip seated rows and can also be used for a bar on a landmine attachment. Get creative!
- PERFECT FOR ALL ENVIRONMENTS- Perfect for home, large busy gyms, small studio gyms, etc.

		per set
Code	Set	MRP.
XP2432	6 pcs set	39,000.00



**CODE XP2433**  
**FUNCTIONAL TRAINING TYRE**

- Rubber & metal construction
- Possible to add olympic weight plates for extra weight
- Shock pads on metal base absorb noise & prevent damage to floor
- Add weights if you want to train heavier .
- It enables you to build muscle & burn fat at the same time.

		per pc
Code	Size	MRP.
XP2433	(L) 137 X (B) 61 X (H) 36 CM 54 x 24 x 14 Inch	1,15,000.00



**CODE XP2434**  
**LEATHER WEIGHTLIFTING BELT**

- Quality: Pieced together with multiple layers of extremely high quality leather to provide an extremely durable 10 mm protection.
- Custom fit: over time the high quality leather silicone mould and takes shape with the contours of your back to provide a customised fit to best serve the owner.
- Ease of use: Once Assembled the lever belt can be easily removed after a lift using the lever mechanics. Time is not wasted Wrestling with the prongs of a regular belt.
- Performance: With abdominal and lower back muscles safely secure lifters have more confidence lifting heavy and more often.

		per pc
Code	Size	MRP.
XP2434	S, M, L, XL	4800.00



**CODE XP2438**  
**POST LAND MINE**

- FITS 2-inch OLYMPIC BARS: with 8-inch long pivot bar sleeve and 4-inch long base post to fit 2-inch Olympic bars and weight plates.
- EASY TO INSTALL with SECURE KNOB: Insert bar and weight plates (weight plates over 25 lbs) into the sleeves and tighten the bar in place with the secure knob.
- FULL 360 DEGREE SWIVEL: Full range swivel up and down for variety of exercises. Great for total body core workout: traps, biceps, back, shoulders, ABS, hamstrings and much more.
- HEAVY GAUGE STEEL CONSTRUCTION: Pivot sleeve made of thick steel and base post of solid steel with Electrostatic Powder Coating for overall secure attachment and durability.



Code	MRP.
XP2438	3350.00

**CODE XP2439**  
**T-BAR**

- T- Bar Row Grip is constructed from heavy duty steel and strong to handle large amounts of weight.
- Landmine t bar, can be attached to under a door, pipe or drilled onto ground. Fits 1-inch standard and 2-inch olympic bars: fits all standard and olympic bars.
- Great for total body workout: triceps, biceps, back, shoulders, abs, hamstrings and legs. Package Contents 1 T Bar Equipment



Code	MRP.
XP2439	13,800.00

**CODE XP2440**  
**BAR HOLDER 9 PCS**

- Made with a 4.5 mm thick Laser Cut Steel Frame, it is enabled to handle the vertical load in a footprint of just 460mm x 460mm. The solid steel bottom keeps the bars straight and upright. Pipes welded with the ERW technique are machined for a smooth internal finish free from burrs and weld spatter, which protects your barbell sleeve from any kind of scratches or damage.
- Organize up to 9 bars of different types in a compact space.
- Protects barbell sleeves against scratches or damage.
- Compatible with Standard Olympic Barbells as well as specialty barbells.
- Easy to use and put away.

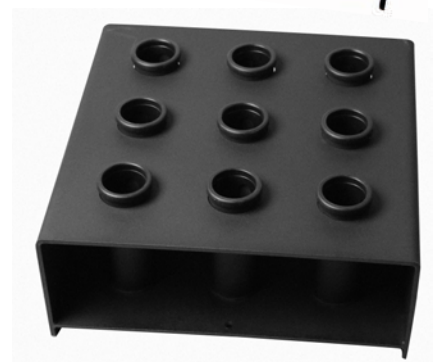

Code	MRP.
XP2440	15,400.00

**CODE XP2441**  
**WOODEN PULL UP MOUNTED**

- Available sizes. 180x30x3.8 cm
- Strength and coordination workout of your entire body through climbing movements
- Can put multiple boards side by side to create desired climbing lengths
- Two dowel peg handles included
- Mounting accessories included

per set		
Code	Size in CM	MRP.
XP2441	180x30x3.8 cm	14,000.00



**CODE XP2442**  
**WOODEN JUMP BOX**

- EXPLOSIVE WORKOUT: Plyometric movements are quick and explosive. Jump Box training improves SPEED and POWER. Jumping exercises increase muscle power and burn lots of calories.
- ADVANTAGES: This plyometric box allows you to train on three different heights. Plyo box is used for box jumps and for other exercises like dips, Elevated push ups. Its an excellent tool for a full body workout. The workout targets the legs, back, arms, core
- FEATURES: A wooden Plyo Jump Box. It has two handles on both sides for you to move and turn it easily.

per pc		
Code	Size in Inch	MRP.
XP2442	20x24x30 inch	16,000.00
	16x20x24 inch	12,000.00
	12x14x16 inch	7000.00



**CODE XP2443**  
**BARBELL PAD**

- Can hold the barbell stably, to buffer the shock and effectively disperse the pressure from the weights with its superb large force bearing area Protect your neck
- It made from an high grade Thermoplastic Elastomer (TPE) which ensures they will not split or crack.
- Ideal for weight training, Cross fit, general fitness training etc
- Lightweight, easy to carry

per pc	
Code	MRP.
XP2443	1300.00



**CODE XP2450**  
**WEIGHT BAR**

- One of the best ways to shape up and add muscle definition to your body is to start strength training.
- This doesn't mean you need to head to the closest gym and start training for a body building competition – all this means is that you should use some form of weight, whether it's your own body weight or an external source of added weight, during exercise at least two times per week.
- AT A GLANCE: Solid steel core Padded foam surface Color coded Different weights to choose.



		per pc
Code	Size in KG	MRP.
XP2450	8 KG	6000.00
	10 KG	7200.00

**CODE XP2451**  
**ELBOW SLEEVE**

- Thermal neoprene elbow support with nylon on both sides.
- Heavy-duty outer nylon for durability. Contoured and darted seams for superior fit.
- Latex -free neoprene construction provides thermal/compression therapy and soft tissue support to promote healing.
- Outer heavy-duty nylon for durability



		per pair
Code	Size	MRP.
XP2451	XS, S, M, L, XL, XXL	1200.00

**CODE XP2452**  
**KNEE SLEEVE**

- High-quality thinnest knee sleeve
- Provides compression & warmth to the knee
- Lightweight and flexible
- Perfect for endurance athletes
- Keep knee warm
- Great for long-time use
- Easy to use



		per pair
Code	Size	MRP.
XP2452	XS, S, M, L, XL, XXL	1550.00

**CODE XP2447**  
**HALF RACK**

- Multi-position handles for exercise variation.
- 8 extra weight horns to store additional weight plates.
- Spotter arms to place the barbell for different exercises.
- J-hooks to rest the bar.
- Multiple holes to adjust the J-hook at the required height.
- The Power Rack has sufficient space to hold an adjustable bench for performing a variety of exercises

RUST PROOF		
Code	Size	per pc MRP.
XP2447	STD	46,200.00



**CODE XP2448**  
**POWER SLED**

- Heavy duty metal construction
- Completely collapsible for flat packaging
- Can use the middle part separately
- Size: Apx: 100x60cm(40"x24")

RUST PROOF		
Code	Size	per pc MRP.
XP2448	40x24 inch	21,000.00



**CODE XP2449**  
**SAFETY BAR**

- Heavy Duty chromed and knurled Olympic bar
- Padded for maximum safety and comfort.
- Forces the user to maintain correct torso alignment.
- Ideal for upper back, lower back, and legwork.
- Great for addressing weak points in the squat.
- Maximum load Capacity: 270kg

RUST PROOF		
Code	Size	per pc MRP.
XP2449	40x24 inch	22,200.00



**CODE XP2453**  
**ASSAULT AIR BIKE**

- Lightweight and Tough Reinforced Nylon Construction
- Solid Construction
- Larger LCD monitor displaying Time, Speed, Distance, RPM, Watts, Calories & Pulse
- Handlebar :Round tube
- Display: time, distance, calories, speed heart rate,etc.
- Drive :Belt +Chain
- Machine size:1293\*592\*1229mm
- Machine weight:49kg | Gross Weight:55kg

		per pc
Code	Size	MRP.
XP2453	51x23.4x48.4 inch	1,59,600.00

**CODE XP2454**  
**ROWING MACHINE**

- Heavy Duty Commercial Air Rower.
- Solid steel frame.
- Wide straps are provided to ensure optimal foot placement and comfortable rowing position.
- Adjustable footrest with numbered seating
- Max. User Weight: 230 Kg
- Machine Size:235\*63\*36-108cm
- N.W.:32kg G.W.:35KG
- Display:Speed/Time/Dis./Calories
- System:Wind resistance Rowing machine

		per pc
Code	Size	MRP.
XP2454	92.5x24.8x14-42.5 inch	1,84,800.00

**CODE XP2455**  
**AIR RUNNER**

- Running belt: high-strength plastic running belt, better elasticity, lower joint impact, safer and more reliable
- The column adopts 170X66X3mm D-type high quality tube, which is beautiful and firm.
- Display panel: 5-inch button control panel, which can display time, speed, distance, calories
- Running area: 1500mm\* 440mm
- Safe speed limit: 0- 20km/h
- Machine size: 1780\*845\* 1520mm
- N.W. 150KG G.W. 170KG
- Max Weight load: 150KG

		per pc
Code	Size	MRP.
XP2455	70x33.25x60 inch	2,64,000.00





**XPEED**  
CRAFTED FOR CHAMPION



## CODE XP1401 BACK PACK BAG

- Heavy duty textured nylon.
- Side mesh drink bottle holders.
- Three handy storage compartments.
- Heavy duty zip pulls and adjustable shoulder straps.
- Double zip allows easy access to all items
- Padded adjustable shoulder straps make it comfortable to carry.

Code	Size	Color	MRP.
XP1401	16x13x6 inch	Black/Orange Black/Green	1250.00



## CODE XP1402 CAMOUFLAGE GYM BAG

- Made from heavy duty lined denier for extra durability.
- Can be carried over the shoulder or as a backpack.
- Draw string closure with side zip for easy access.
- Also comes with a reinforced carry handle.

Code	Size	Color	MRP.
XP1402	28x13x4 inch	Black/Blue Black/Green	700.00



## CODE XP1403 GYM BAG

- Made from heavy duty lined denier for extra durability.
- Can be carried over the shoulder or as a backpack.
- Draw string closure with side zip for easy access.
- Also comes with a reinforced carry handle.

Code	Size	Color	MRP.
XP1403	35x20x20 CM	Black/Green	850.00



**CODE XP1404**  
**DOUBLE POCKET BAG PACK**

- A large main compartment with U-shaped zip and
- 2 large end pockets.
- Adjustable shoulder strap and studded base.
- Side straps for holding bottles or any other essentials kept

Code	Size	Color	MRP.
XP1404	23x12x12 inch	Black/Orange	1800.00



**CODE XP1405**  
**DOUBLE POCKET BAG PACK**

- A large main compartment with U-shaped zip and
- 2 large end pockets.
- Adjustable shoulder strap and studded base.
- Side straps for holding bottles or any other essentials kept

Code	Size	Color	MRP.
XP1405	23x12x12 inch	Black/White	1800.00



**CODE XP1406**  
**CAMOUFLAGE DOUBLE POCKET BAG PACK**

- Heavy Padding at the back and the shoulder straps for more comfort- Lightweight and water proof material.
- Side straps for holding bottles or any other essentials kept
- Adjustable breathable shoulder straps ensure a proper fit and comfortable use straps.

Code	Size	Color	MRP.
XP1406	23x12x12 inch	Camouflage	1850.00







# CRICKET WICKETS & BALLS

CODE XP2201  
**PLASTIC STUMP SET**  
Full Size

per set

Code	MRP.
XP2201	660.00



CODE XP2202  
**WOODEN STUMP SET**  
SPRING STAND

per set

Code	MRP.
XP2202	2650.00



CODE XP2203  
**WOODEN MALLET**

per pc

Code	MRP.
XP2203	550.00



CODE XP2204  
**WOODEN HAMMER**

per pc

Code	MRP.
XP2204	300.00



CODE XP2205  
**GRIP APPLICATOR**

per pc

Code	MRP.
XP2205	280.00



CODE XP2206  
**WOODEN BAILS PER PAIR**

per pair

Code	MRP.
XP2206	100.00



**CODE XP2301  
TRAINING BALL**

per pc	
Code	MRP.
XP2301	450.00



**CODE XP2302  
ABDOMINAL GUARD**

per pc		
Code	SET	MRP.
XP2302	Boy, Youth, Mens	90.00



**CODE XP2303  
ABDOMINAL GUARD WITH HOLE**

per pc		
Code	SET	MRP.
XP2303	Boy, Youth, Mens	100.00



**CODE XP2304  
MOULDED ABDOMINAL GUARD**

per pc	
Code	MRP.
XP2304	120.00



**CODE XP2305  
COTTON INNER GLOVES**

per pair	
Code	MRP.
XP2305	230.00



**CODE XP2306  
FINGERLESS GLOVES**

per pair	
Code	MRP.
XP2306	200.00



**CODE XP2307  
CHAMOIS INNER GLOVES**

per pair	
Code	MRP.
XP2307	600.00



**CODE XP2308**  
**SAUCER CONES (SET OF 50)**  
 per set

Code	MRP.
XP2308	1150.00



**CODE XP2309**  
**AGILITY LADDER**  
 per pc

Code	SIZE	MRP.
XP2309	4 mtr	600.00
	6 mtr	850.00
	8 mtr	1100.00



**CODE XP2310**  
**SPEED HURDLE**  
 per pc

Code	SIZE	MRP.
XP2310	6"	230.00
	9"	250.00
	12"	280.00
	15"	300.00

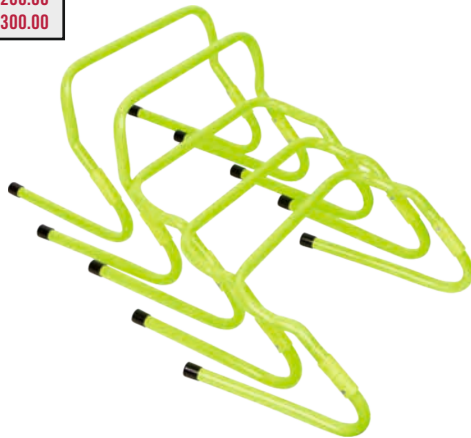

**CODE XP2311**  
**RUBBER SPOTS (PACK OF 24)**  
 per set

Code	SET	MRP.
XP2311	24 Pcs	1800.00



**XP2312**  
**DOMES MARKING CONES (SET OF 50)**  
 per set

Code	SET	MRP.
XP2312	50 Pcs	2100.00



**CODE XP2313**  
**CONES**  
 per pc

Code	SIZE	MRP.
XP2313	6"	50.00
	9"	70.00
	12"	110.00
	15"	210.00



## CODE XP2456 WOODEN DART BOARD CABINET

High quality OEM wooden dart board cabinet sets with 18" dart board Perfect your aim and enjoy some friendly competition with this Official Dart Board Set ! Crafted with high-quality, durable materials that provide a stunning wood accent, the material of dart board is sisal, 18-inch dart board that makes it ideal for gameplay. Whether you're looking for the finishing piece for your personal game room or designing the perfect space for game night with the guys, this dart game for adults will provide endless fun and competition! This all-in-one dart board scoreboard comes complete with 6 darts that are perfect for two-player games, so you can start a match right out of the box. There are dart holders to keep everything organized between matches, and sturdy doors to keep the whole game tucked away when not in use. Plus, this dart board scoreboard is dry erase, allowing you to easily keep track of the game and just wipe the score away when finished. You'll always be ready for another round! we are committed to providing superior, incredibly fun game room games that will always let you enjoy the next match. This darts scoreboard cabinet has been designed with the quality and care you deserve so you can always enjoy a fantastic game! Aim for the bullseye and achieve your hat trick with this darts game set for adults!

Style: Indoor Game

Size : 685x530x86 mm

Dart board size: 18 inch

Colour: Customized colour Acceptable

Material: Sisal

Accessories:3 white and 3 black Dart, a white erasable pen, two sets of black door suction iron ect.

per set

Code	Size	MRP.
XP2456	685x530x86 mm	27,600.00



## FOOSBALL SOCCER TABLE

### CODE XP2457 SOCCER TABLE

Hot selling professional football table with modern outlook. Chromed bands on 4 corners bring modern aesthetic beauty to the classic table and make it more durable. Drink holders provide players extra fun and convenience. Reinforced Legs with added strength from cross bar support and 5" leg levelers guarantee fair and even play. Its size is suitable for most places. Abacus style manual scorers make score tracking easy handling. Below is the specification sheet for soccer table Hopefully, it would be able to give you more details on this product.

Table size:54"x30"x34", 137x76x86cm

Playfield: MDF

Aprons:: MDF

Player rods: 15.8mm strong chromium steel with wood handle Goalie

rod:choice between one and three men goalie Scorers: wood manual slide scorers

Ball insert:at each side apron

Ball return:internal at each end apron

Balls: 2pcs

Legs: MDF

Cross bar: stainss steel

Cup holder:2 pcs included

Packing: 1pc/ctn full K/D

Code	Size	MRP.	per set
XP2457	137x76x86cm	42,600.00	



# AIR ICE HOCKEY TABLE

**CODE XP2458**

## AIR & ICE HOCKEY TABLE

**ELECTRONIC SCORING:** Electronic scorer is much easier to operate. The player doesn't need to spend time recording the score. The score is automatically displayed on the screen and is very accurate. **SUITABLE PLACES:** This 6ft air hockey table is perfect for family fun and can be put in rooms, garages, basements and out yards, as well as in bars, game rooms and other entertainment venues. **ADJUST LEG LEVELERS:** The leg level adjustment system makes the table adjustable in the case of uneven floors to suit your environmental needs to make the game as accurate and fair as possible. **EASY ASSEMBLY:** After opening the package, the table is already in a semi-assembled state, and only the legs of the table are needed to complete the assembly of the product. It only takes two people 20 minutes to complete it, which is very simple.

Below is the specification sheet for soccer table it would be able to give you more details on this product.

Table size: 72"x38"x32", 183\*91\*81CM

Playfield: MDF

Side rail: MDF

Rail corner: ABS

Scorers: electronic scorer

Legs: MDF

Leg panels: MDF

Leg levelers: ABS

Pucks: 2pcs

Strikers: 2pcs

Power: suitable for 50HZ 230V outlets

Packing: 1pc/ctn half K/D

per set

Code	Size	MRP.
XP2458	183x91x81cm	86,400.00
	213x91x81cm	1,02,000.00



**CODE XP4100**  
**FOLDING TABLE TENNIS TABLE**

**15MM**

**Product Description**

- PLAYFIELD: 15MM
- APRON:20\*30MM
- LEGS:POWDER COATED STEEL SQUARE SHAPED TUBES(35\*35MM)
- WHEELS:75MM
- FUNCTION :FOLDING + REMOVABLE
- COLOR: BLUE
- PACKING:1PC/CTN
- NET POST:1SET
- USAGE:INDOOR
- PACKING:1PC/CTN
- INSTRUCTION SHEET:INCLUDED

274\*152.5\*76CM

Code	Size	MRP.
XP4100	274x152.5x76CM	<b>38,400.00</b>

**25MM**

**Product Description**

- playfield: 25mm
- apron:20\*50mm
- legs:powder coated steel square shaped tubes(50\*50mm)
- wheels:100mm
- Function :Folding + Removable
- Color: Blue
- packing:1pc/ctn
- net post:1set
- Usage:Indoor
- packing:1pc/ctn
- instruction sheet:included

274\*152.5\*76cm

Size	MRP.
274x152.5x76CM	<b>52,800.00</b>



## CODE XP2459 CAMPING TENT LIGHT

- Great sleeping capacity: The spacious dome shape tent enables 4 people to sleep in with comfort large space and ultimate protection against leaks
- Thoughtful design: A top mesh window allows the inner air more breathable, the outer curtain can roll up so as to keep ventilating and a durable zipper enables to instantly open for easily entry/exit
- Protects from wind, sunlight, rain, insects breathable fabric and Durable water resistant with coated-polyester fabric and Ideal Camping and Outdoor activities
- Two large zippered d-shape door, dual zipper, easy to get in and out excellent ventilation mesh proof
- Liability features such as comfort and convenience and easy setup in only 10 minutes
- Material: Polyester tuft cloth, fiberglass rod
- Size : 200X120X105cm 1.1kg **per pc**

Code	Size	MRP.
XP2459	200x120x105cm	2600.00



## CODE XP2460 CAMPING TENT HEAVY

- Great sleeping capacity: The spacious dome shape tent enables 4 people to sleep in with comfort large space and ultimate protection against leaks
- Thoughtful design: A top mesh window allows the inner air more breathable, the outer curtain can roll up so as to keep ventilating and a durable zipper enables to instantly open for easily entry/exit
- Protects from wind, sunlight, rain, insects breathable fabric and Durable water resistant with coated-polyester fabric and Ideal Camping and Outdoor activities
- Two large zippered d-shape door, dual zipper, easy to get in and out excellent ventilation mesh proof
- Liability features such as comfort and convenience and easy setup
- Material: Polyester tuft cloth, fiberglass rod
- Size:200\*150\*115cm 2KG

Code	Size	MRP.
XP2460	200x150x115cm	4600.00



## SLEEPING BAG

**CODE XP2461**

### BACKPACKING LIGHTWEIGHT SLEEPING BAG

- **GOOD QUALITY WITH AFFORDABLE PRICE.** The stitching and material feels neat and comfortable. Outer Cover Material: 190T Nylon, Waterproof and Breathable Fabrics; Lining Material: Polyester Pongee; Fill-Material: hollow cotton. **WARM AND SKIN-FRIENDLY**
- **A THOUGHT OUT DESIGN.** Drawstring allows you to tighten hood and **KEEP YOU HEAD NICE AND WARM.** The idea of having a zipper at the foot to allow more warm or cool air to enter or exit the bag in different times of the season
- **LIGHTWEIGHT AND COMPACT DESIGN.** Convenient to carry along for any outdoor adventures, class camping trip, the aquarium, summer camp, couch surfing, jam bags, office crashing, and as an emergency blanket for vehicles
- **SERVE ITS PURPOSE FOR YOU AND YOUR KIDS.** Wipes clean easily. This camping bag also have a weather-resistant and waterproof design to keep you warm, prevent you from any dampness

per pc

Code	Size	MRP.
XP2461	180x75 cm (800g)	2900.00



**CODE XP2462**

### BACKPACKING HEAVYWEIGHT SLEEPING BAG

- **GOOD QUALITY WITH AFFORDABLE PRICE.** The stitching and material feels neat and comfortable. Outer Cover Material: 190T Nylon, Waterproof and Breathable Fabrics; Lining Material: Polyester Pongee; Fill-Material: hollow cotton. **WARM AND SKIN-FRIENDLY**
- **A THOUGHT OUT DESIGN.** Drawstring allows you to tighten hood and **KEEP YOU HEAD NICE AND WARM.** The idea of having a zipper at the foot to allow more warm or cool air to enter or exit the bag in different times of the season
- **HEAVYWEIGHT AND COMPACT DESIGN.** Convenient to carry along for any outdoor adventures class camping trip, the aquarium, summer camp, couch surfing, jam bags, office crashing, and as an emergency blanket for vehicles
- **SERVE ITS PURPOSE FOR YOU AND YOUR KIDS.** Wipes clean easily. This camping bag also have a weather-resistant and waterproof design to keep you warm, prevent you from any dampness

per pc

Code	Size	MRP.
XP2462	180x35x70cm (850g)	1550.00



**XP2463**

### AIR BED

- Flocked twin size air bed
- 2 in 1 valve, easy to inflated & deflated
- Materials: 0.32mm thickness PVC (0.54mm thickness after flocked)  
With repair patch
- Packing: 1pc/color box, then 6pcs/carton
- N.W./G.W.: approx. 1.3kgs/approx. 1.5kgs

per pc

Code	Size	MRP.
XP2463	191x73x22cm (1.85kg)	2150.00



## CAMPING CHAIR

### CODE XP2464 FOLDING CAMPING CHAIR

- Foldable Camping Chair with Armrest Cupholder for Indoor/Outdoor Use
- No Assembly Required for instant enjoyment
- 300D Black Canvas Fabric with PE Coating for weather resistance
- Polypropylene Floor Glides prevents damage to indoor flooring
- Clean with Water and a Dry Cloth to maintain the appearance
- Collapsible chair ideal for any event where seating is needed

per pc	
Code	MRP.
XP2464	3000.00



### CODE XP2465 FOLDING CAMPING CHAIR

- Foldable Camping Chair.
- No Assembly Required for instant enjoyment
- 300D Green Canvas Fabric with PE Coating for weather resistance
- Polypropylene Floor Glides prevents damage to indoor flooring
- Clean with Water and a Dry Cloth to maintain the appearance
- Collapsible chair ideal for any event where seating is needed

per pc	
Code	MRP.
XP2465	1000.00



### CODE XP2466 FOLDING CAMPING TABLE

- Camping Table
- Folding Table or Stool
- Adjustable Table Height
- Material : Canvas

per pc	
Code	MRP.
XP2466	450.00



**NEW  
ARRIVAL**

**CODE XP1239**

**HEAVY BOXING TRAINER WITH PROTECTION COVER**

- Durable and high-quality construction for intense training
  - Includes a protective cover to enhance longevity and maintain shape
  - Provides a safe and effective way to practice punches and strikes
  - Sturdy design ensures stability during high-impact training
  - Ideal for improving striking skills, power, and hand-eye coordination
- Total height:195cm

COMPONENTS	DETAILS
Punching Bag	Padded PU foam, Outer::PVC Weight: Size:42cm (dia.) x 132cm (H)
Protective cover	Outer: Protection, Cover : PU Foam/PVC Size: 42cm (dia.) x 27 cm (H)
Spring set	Inner: Rubber / Steel, Cover : PE Spring size: 16cm (dia.) x 31cm (H)
Base	Materials : HDPE Dims: 810mm (dia.) x 35.5cm (H) The base tank with water is about 140 kgs

Size	Color	MRP.
180 inch apx.	Black	46,800.00



**CODE XP1246**

**HIGHER BOXING PUNCHING BAG MEDIUM**

- The Body Gym Boxing Punching Bag [Medium] is a boxing punching bag that functions similarly to a punching bag.
- Those living in Europe are more familiar with punching bags, and their function is the same, just a different way of calling them.
- For those of you who enjoy fighting sports like boxing or Muay Thai, a punching bag is a very important training tool.

Size	Color	MRP.
182cm x 56cm	Black	24,960.00



**CODE XP1240**

**BOXING MAN WITH PROTECTION COVER**

- Improved boxing rubber, filled with urethane foaming
- Elastomeric spring action.
- Plastic base with space.

COMPONENTS	DETAILS
Dummy	Material : PU, Size : 69cm (H) x 53cm (W) Weight: 5.5kg±100g
Spring Set	Inner : Rubber/Steel, Cover : PE Spring size : 17cm (dia.) 33cm (H).
Cover	Inner: PU FOAM / OUTER : PVC SHELL SIZE : OUTER DIA DIA. : 29cm / thickness:cm height : 36cm
Base	Materials : HDPE Dims : 530mm (dia.)x71 cm (H)/6.5kgs Base with water is about 110-120kgs

Size	Color	MRP.
69cm (H)x53cm (W)	Black	58,800.00



**CODE XP1247**

**BOXING PUNCHING MAN**

- Punching Man- Imitating human body. A great partner for sparring techniques or target training. Great for throwing power shots.
- Helps develop accuracy. Made from high strength plastisol.
- Filled with urethane foam for durability.
- The base can be filled with water or sand.
- Best choice for fitness including kicking and punching training.
- Suitable for professional gyms and home use

Size	Color	MRP.
172cm x 57 cm	Skin	53,400.00



**CODE XP1248**  
**ADJUSTABLE PUNCH MAN**

- Plastic/PU construction
- Elastomeric spring action
- Plastic base with cavity Can be filled with 100-110 Kg of sand

Size	Color	MRP.
Medium	Black	36,000.00



**CODE XP1252**  
**BOXING REFLEX BALL**

- The reflex ball is a training tool for men and can train your reaction speed, accuracy, hitting ability, eye-hand coordination ability and defense ability.
- Portable and lightweight.
- Take your men's training equipment with you everywhere,
- Adjustable Headband Boxing ball suit with adjustable headband Both adults and children can wear boxing reflex ball head easily and eatable more comfortable to wear

Size	Color	MRP.
Std	Black	720.00



**CODE XP1254**  
**MASK PUNCHING MITT**

- Realistic Face Design: Offers a lifelike target, helping fighters perfect their strikes on a more realistic surface.
- Comfortable Grip: Ergonomically designed hand compartment ensures a secure and comfortable grip for trainers or partners.
- Durable Build: Made from high-quality rubber and filled with PU foam for lasting strength.
- Multi-Sport Use: Perfect for Taekwondo, boxing, kickboxing, Muay Thai, and MMA training.
- Skill Enhancement: Helps improve kicking technique and accuracy with a realistic training surface.

Size	Color	MRP.
Std	Black	6,000.00



**CODE XP1257**  
**AQUA AIR PUNCH BAG**

- Material: High-quality PVC with advanced sealing technology. ( Inflation Valve of Inflatable Boat
- Even Weight and Uniform Water Distribution
- Versatile Performance, the ultimate customizable heavy bag
- Provides realistic rebound for maximized strength gains.

Size	Color	MRP.
180cm x 35dia	Black	23,300.00



**CODE XP1262**  
**AQUA AIR PUNCH BAG**

- Built to last, with a durable outer shell made of high-quality vinyl that can withstand even the most intense training sessions.
- Excellent tool for improving your punching power, speed, and accuracy, as well as your footwork and overall technique.
- Improve your cardiovascular endurance and burn calories.
- Easy to set up and maintain.

Size	Color	MRP.
15" inch	Black	10,900.00



**CODE XP1263**  
**AQUA AIR PUNCH BAG**

- Built to last, with a durable outer shell made of high-quality vinyl that can withstand even the most intense training sessions.
- Excellent tool for improving your punching power, speed, and accuracy, as well as your footwork and overall technique.
- Improve your cardiovascular endurance and burn calories.
- Easy to set up and maintain.

Size	Color	MRP.
18 " Inch	Black	11,500.00





**CODE XP2506**  
**FOAM ROLLER MEDIUM DENSITY**

- Xpeed Medium Density Foam Roller Build a better body with our premium Xpeed
- Colour Available : Green/ Blue

Size	Color	MRP
30 CM	Green, Blue	1450.00
45CM		1700.00



**CODE XP2507**  
**FOAM ROLLER CONFETTI**

- Xpeed Medium Density Foam Roller Build a better body with our premium Xpeed

Size	Color	MRP
30 CM	Confetti	1550.00
45CM		1800.00



**CODE XP2508**  
**MASSAGE BALL CONFETTI**

- Medium density
- EPP foam for unmatched durability

Size	Color	MRP
8 CM PACK OF 1	Confetti	950.00
12 CM PACK OF 1		1200.00



**CODE XP2509**  
**DUO MASSAGE BALL CONFETTI**

- Relieve tight muscles
- Reduce soreness & stress
- Reduce inflammation
- Increase blood flow and circulation

Size	Color	MRP
8 CM PACK OF 1	Confetti	850.00
12 CM PACK OF 1		1100.00



**XP 1231**  
**BARBELL PAD BACK**

- High Density EVA Foam
- Curved design for superior neck support
- 2 straps that secure your safety
- Antislip Design
- Universal fit for all olympic size

Size in cm	Color	MRP
42x3 cm	Black	000.00



**XP 902**  
**WOMEN WEIGHTLIFTING GLOVES**

- Microsuede top hand panelling for strength and performance.
- Silicon embossed palm
- Tailored to fit women's hands comfortably
- Adjustable for a secure Velcro closure
- Enhanced Grip and Control

Size	Color	MRP
S/M	Black/Green	900.00
L/XL	Black/Red	



### XP 903

#### NUCLEAR WEIGHTLIFTING GLOVES

- Mesh on back for Ventilation
- Microsuede top hand panelling for strength and performance.
- Contoured anatomical design with neoprene wrist cuff and velcro closure
- Breathable and Sweat-Wicking

Size	Color	MRP
S/M	Black/Red	900.00
L/XL	Black/Blue	



### XP 904

#### INVADER WEIGHTLIFTING GLOVES

- Mesh on back for Ventilation
- Contoured anatomical design with elasticated wrist cuff and velcro closure
- Breathable and Sweat-Wicking

Size	Color	MRP
S/M	Black/Red	930.00
L/XL	Black/Blue	



### CODE XP4151 BOW BARBELL

- A specialized barbell meticulously crafted for optimal performance. Engineered with a bent and cambered design, this bar ensures a more natural placement on your shoulders, enhancing comfort during workouts.
- Material: High-grade alloy steel
- Diamond Knurling for a secure grip
- Bushings for smooth rotation
- Length 2.2 M

MRP

14,400.00



### CODE XP4152 OB HANDGRIP BAR

- The OB Bar has hand grips with rotating handles, Perfect to target different grip positions, allowing wrist movement for the optimum workout! Can be used as a standard bar or can be attached to a cable machine
- 50mm sleeve, fits Olympic Plates
- Length 1.2m bar, Weight 14.8kg

MRP

18,000.00



### CODE XP4153 Open Hex Bar

Hexagonal frame design with two parallel handles  
Encourages a more upright posture during lifting, potentially reducing strain on the lower back  
Facilitates optimal lifting position for movements such as the hex bar deadlift  
Ergonomic handles offer a comfortable and intuitive grip  
Suitable for individuals with limited mobility  
Dimensions: 50x50x3mm

MRP

28,200.00



### CODE XP4154 HEX TRAP BAR

- Rotating handle allow the user to choose which grip works the best
- Rubber stoppers Protects the floors from damage or scratching.
- Unique design ensures correct lifting form allowing midline center of gravity to stay balanced
- Builds muscle like Shoulder shrugs, squats, and deadlifts are the primary lifting funi muscle strength to shoulders, back and legs
- Size : 50x50x2mm

MRP

22,700.00



**CODE XP4155**  
**MACHINE ACCESSORIES RACK**

- Durable and Dependable: Crafted from top-quality materials and built with meticulous attention to detail, this accessory rack is engineered to withstand the wear and tear of a busy gym environment. It's a long-lasting investment in keeping your gym in top form.
- Multi-Function Storage: The thoughtful design of this rack provides ample storage for a variety of gym accessories, including cable attachments, resistance bands, belts, chains, jump ropes, and more. It keeps your equipment easily accessible and ready for use.
- Space-Saving Design: The Muscle D Fitness Accessory Rack is compact and space-efficient, making it ideal for gyms of all sizes. Its sleek and modern aesthetics blend seamlessly with your gym's design.

---

MRP  
**18,600.00**

---



**CODE XP4156**  
**KETTLE BELL RACK**

- Heavy Frame Design makes extremely stable rack
- 3 Tier Design maximizes space
- Angled Trays allow easy lift off and eliminate wrist strain
- Standard Color platinum silver frame
- Rubber Feet prevent sliding

---

MRP  
**32,400.00**

---



**CODE XP4157**  
**DUMBBELL RACK**

- Heavy Frame Design makes extremely stable rack
- 2 Tier Design maximizes space
- Angled racks allow easy lift off and eliminate wrist strain
- Low profile is ideal for placement on mirrored walls
- Standard Color titanium silver frame
- Rubber Feet prevent sliding

---

MRP  
**41,000.00**

---



**CODE XP4158**  
**MACHINE ACCESSORIES**

- For gym use
- Includes 10 different pulley handles
- Allows for several different grips and directions of movement
- Available with a stylish pedestal stand
- Really high-quality ergonomic handles that give you a firm grip

---

MRP  
**55,000.00**

---



**CODE XP4103**  
**POWER RACK - TIGER**

- HIGH QUALITY MATERIAL: 2.5x2.5" (60x60mm) Heavy-duty 12-Gauge steel is constructed to ensure the Power Rack's durability and stability. The whole equipment is covered with powder coating to prevent chipping, rust and corrosion under workout condition.
- FRAME DESIGN: The Power Rack features an Cage Frame structure with additional support frames, ensuring a remarkable load-bearing capacity of up to 750 KGS. Say goodbye to concerns about equipment breakage during your workout sessions.
- VERSATILE FITNESS EQUIPMENT: You can perform Weightlifting, Strength Training, Bench Press, Squat rack with Adjustable J-Clamps for Easy use.

Size	MRP.
(W) 46 X (L)48 X (H) 90"	<b>84,000.00</b>



**CODE XP4104**  
**POWER RACK ECONOMY - 2.0**

- Compact footprint, ideal for home gyms with limited ceiling height
- Integrated multi-grip pull-up bar
- Safety spotter arms and J-hooks included
- Weight Capacity: 700 lbs (317 kg)
- Plate-loaded system with carriage for smooth operation
- Includes lat bar and low row handle

Size	MRP.
(W) 47 X (L)45.5 X (H) 86"	<b>85,000.00</b>



**CODE XP4105**  
**POWER RACK**

- Compact footprint, ideal for home gyms with limited ceiling height
- 2" x 2" heavy-duty steel frame construction
- Integrated multi-grip pull-up bar
- Safety spotter arms and J-hooks included
- Weight Capacity: 700 lbs (317 kg)
- Plate-loaded system with carriage for smooth operation
- Includes lat bar and low row handle

Size	MRP.
(W) 47 X (L)45.5 X (H) 86"	<b>54,000.00</b>



**CODE XP2424**  
**BENCH SET**

**Specification**

Material : Metal  
 Finish : Anti rust powder coated  
 Colour : Black  
 Max. Load capacity : 250 kg.

Size	MRP
(L) 158 X (B) 75 X (H) 56 CM 62.25 x 29.5 x 22 Inch	<b>35,900.00</b>



**CODE XP4168**  
**WEIGHT LIFTING PAD**

- Made from durable dense foam with an easy clean PVC cover.
- Reduce noise and vibration from dropping barbells.
- Easy carry handle for transportation and storage
- Drop Pad for soundless Training
- Pads are a compact and budget-friendly alternative to commercial platforms.

Size	MRP.
180x30x3.8 cm	<b>18,000.00</b>



**CODE XP4159**  
**3 in 1 Jump Box**

- Versatile: This 3-in-1 jump box can be used as a 20inch, 24inch, or 30inch plyometric box for varied exercise intensity.
- Durable Construction: Made from high-density foam with a sturdy vinyl cover for long-lasting performance.
- Portable Design: Lightweight and foldable for easy storage and transportation.
- Non-Slip Surface: Textured top provides secure footing during exercises.

Size	MRP.
180x30x3.8 cm	<b>18,600.00</b>



**CODE XP4160**  
**PUSH UP BAR**

- Ergonomic design: Look for pushup bars that are designed to support your wrists and allow for a comfortable grip during your workout.
- Stability: Choose pushup bars that have a stable base to prevent them from slipping or wobbling during use.
- Portability: If you plan to take your pushup bars with you when you travel, look for lightweight and portable options that are easy to pack.
- Non-slip grip: Look for pushup bars with a non-slip grip to ensure your hands don't slip during your workout.

Size	MRP.
180x30x3.8 cm	<b>1650.00</b>



**CODE XP4161**  
**PU DUMBBELL**

- Premium Polyurethane (PU) Coating - Highly durable, wear-resistant, and long-lasting.
- Ergonomic Grip - Designed for comfort, control, and reduced hand fatigue.
- Precision-Balanced - Ensures smooth, stable lifting performance.
- Sleek & Professional Design - Perfect for high-end gym setups

Size	MRP.
5kg	5200.00
10kg	9500.00
12.5kg	11,900.00
15kg	14,300.00



**CODE XP4162**  
**ELITE POWER SLED**

- Durable construction for long-lasting performance, suitable for all fitness level
- Commercial-grade prowler sled
- Innovative three-wheel design for superior stability and smooth movement on any terrain.
- 8 levels of customisable magnetic resistance for tailored workouts.
- Adjustable handlebar and tri-handlebar insert for enhanced comfort during training.
- User-friendly console for tracking real-time metrics like speed, distance, watts, and calories burned.
- Vertical storage capability to save space in your gym.

Size	MRP.
40x24 inch	98,500.00



**CODE XP2481**  
**AEROBIC STEPPER PRO**

- Durable plastic construction
- Adjustable height in 3 step  
15cm, 20cm, 25cm
- Non-slip top surface
- Rubber surface for grip.

Size in cm	Color	MRP
97x37x15cm	Orange/Grey	8650.00



**XP 1102**  
**SLAM BALL**

- Strong rubber construction
- Ideal for slamming exercise
- Non-slip rubber surface

Size in KG	Color	MRP
4kg		1250.00
6kg		1500.00
8kg	Black	1900.00
10kg		2200.00
12kg		2400.00
15kg		3350.00



**CODE XP4163**  
**SOCCER PLAYER**

- Made Of High Quality Durable Abs Plastic.
- Foosball Game Balls Of 28Mm Diameter, Suitable For Table Soccer As Replacement Balls.

Size	MRP.
110x25x35mm	500.00



**CODE XP4164**  
**SOCCER BALL**

Ø36mm ,material: ABS

Size	MRP.
Ø36mm	250.00



**CODE XP4165**  
**AIR ICE HOCKEY STRIKER SET**

Ø96mm Strikers & Ø63mm x 8g pucks of air hockey table made of material use plastic

Size	MRP.
Ø96mm Strikers Ø63mm*8g pucks	700.00



**Code : XP4166**

**Fiberglass pickleball paddle**

Details: The perfect pickleball set for beginners and professional players, with the desired stiffness and surprisingly lightweight. You can experience a perfect balance in great control and power.

INCLUDED Pickleball Paddles \* 2 Pickleball Paddle Bag\* 1 Pickleball Balls \* 4(40-holes outdoor pickleballs\*2 + 26-holes indoor pickleballs\*2)

2 paddle+4balls+1bag

- Paddle Size: 400\*200\*10MM
  - Paddle Shape : Elongated
  - Grip Size:13\*5\*2.8CM
  - Surface Treatment: Cold pressed fiberglass
  - Core Type: Polypropylene honeycomb
  - Thickness: 10mm
  - Edge: TPU edge
  - Graphic Design: Custom design
  - Balls\*4pcs& made of material use PE
  - Weight: 210 g /7.4 oz
  - Packing: Regular bubble bag/custom package
- MOQ:500 PCS



Size	MRP.
400x200x10mm	00,000.00



**Code : XP4167**

**Carbon pickleball paddle**

To make it a more durable pickleball paddle, it is fully encased in carbon. The carbon fiber also allows it to withstand more frequent play and ensures a consistent shot across the life of the paddle.

2 paddle+2balls+1bag

- Paddle Size: 420\*182\*16MM
- Paddle Shape : Elongated
- Grip Size: 14\*4\*3.5CM
- Surface Treatment: Cold pressed 3k Carbon plate UV printing
- Core Type: Polypropylene honeycomb
- Thickness: 16mm
- Graphic Design: Customized design
- Weight: 235 g / 8.3 oz
- Balls\*2pcs &made of material use PE
- Packing: Regular bubble bag/custom package



Size	MRP.
420x182x16mm	00,000.00



**Code : XP4168**

**Fiberglass Pickleball Paddle**

- Paddle Size: 400\*200\*10MM
- Paddle Shape : Elongated
- Surface Treatment: fiberglass
- Core Type: Polypropylene honeycomb
- Thickness: 10mm
- Edge: PVC edge
- Graphic Design: Custom design
- Weight: 225 g
- Packing: Regular bubble bag/custom package

Size	MRP.
400x200x10mm	00,000.00



# SIZE CHART

**XPEED**  
CRAFTED FOR CHAMPION

**BOXING GLOVE**

**Size Chart**



Size	Circumference
4oz	11.00-12.50cm
6oz	12.50-14.00cm
8oz	14.00-16.50cm
10oz	16.50-19.00cm
12oz	19.00-21.50cm
14oz	21.50-24.00cm
16oz	24.00-26.50cm

To estimate the size you need, please use the following chart to compare your measurement. Please note that the guide is an estimate only and cannot account for individual preferences.

[www.xpeedsports.com](http://www.xpeedsports.com)

**XPEED**  
CRAFTED FOR CHAMPION

**HEADGUARD**

**Size Chart**



Size	Headguard circumference in cm	User Height
S/M	74cm	50 - 60 cm
L/XL	79cm	60 - 70 cm

To estimate the size you need, please use the following chart to compare your measurement. Please note that the guide is an estimate only and cannot account for individual preferences.

[www.xpeedsports.com](http://www.xpeedsports.com)

**XPEED**  
CRAFTED FOR CHAMPION

**MMA GLOVE**

**Size Chart**



Size	MMA GLOVE WIDTH IN CM (A)	MMA GLOVE HEIGHT IN CM (A)	CIRCUMFERENCE
S/M	24cm	13.5cm	15-21.50cm
L/XL	24.5cm	14cm	21.50-24.50cm

To estimate the size you need, please use the following chart to compare your measurement. Please note that the guide is an estimate only and cannot account for individual preferences.

[www.xpeedsports.com](http://www.xpeedsports.com)

**XPEED**  
CRAFTED FOR CHAMPION

**BAG GLOVE**

**Size Chart**



Size	Circumference
S	Below 16.50cm
M	16.50-21.50cm
L	21.50-24.00cm
XL	24.00cm above

To estimate the size you need, please use the following chart to compare your measurement. Please note that the guide is an estimate only and cannot account for individual preferences.

[www.xpeedsports.com](http://www.xpeedsports.com)

**XPEED**  
CRAFTED FOR CHAMPION

**SHIN GUARD**

**Size Chart**



Size	Shin Length (A) cm	Shin Length (B) cm	User Length below knee to ankle
S	34	13.5cm	25.5 - 28 cm
M	37.5	15.5cm	29 - 33 cm
L	39	16.5cm	34 - 37 cm
XL	40.5	17.5cm	38 - 41 cm

To estimate the size you need, please use the following chart to compare your measurement. Please note that the guide is an estimate only and cannot account for individual preferences.

[www.xpeedsports.com](http://www.xpeedsports.com)

**XPEED**  
CRAFTED FOR CHAMPION

**WEIGHTLIFTING GLOVE**

**Size Chart**



Size	WEIGHTLIFTING WIDTH IN CM (A)	WEIGHTLIFTING HEIGHT IN CM (A)	User Height Unisex
S/M	24cm	13.5cm	15-16.50 cm
L/XL	24.5cm	14cm	16.50-18 cm

To estimate the size you need, please use the following chart to compare your measurement. Please note that the guide is an estimate only and cannot account for individual preferences.

[www.xpeedsports.com](http://www.xpeedsports.com)

# SIZE CHART

**XPEED**<sup>®</sup> CRAFTED FOR CHAMPION

## POWER WEIGHTLIFTING BELT

**Size Chart**



Size	POWER WEIGHTLIFTING BELT WIDTH IN CM (A)	POWER WEIGHTLIFTING BELT HEIGHT IN CM (B)	User Height
<b>S</b>	<b>104cm</b>	<b>10.5cm</b>	<b>75-98 cm</b>
<b>M</b>	<b>114cm</b>	<b>10.5cm</b>	<b>98-108 cm</b>
<b>L</b>	<b>124cm</b>	<b>10.5cm</b>	<b>108-118 cm</b>
<b>XL</b>	<b>134cm</b>	<b>10.5cm</b>	<b>118-128 cm</b>

To estimate the size you need, please use the following chart to compare your measurement. Please note that the guide is an estimate only and cannot account for individual preferences.

[www.xpeedsports.com](http://www.xpeedsports.com)

**XPEED**<sup>®</sup> CRAFTED FOR CHAMPION

## CHESTGUARD

**Size Chart**



Size	CHESTGUARD WIDTH IN CM (A)	CHESTGUARD HEIGHT IN CM (A)	User Height
<b>S/M</b>	<b>49cm</b>	<b>105cm</b>	<b>134-169cm</b>
<b>L/XL</b>	<b>53cm</b>	<b>116cm</b>	<b>170-190cm</b>

To estimate the size you need, please use the following chart to compare your measurement. Please note that the guide is an estimate only and cannot account for individual preferences.

[www.xpeedsports.com](http://www.xpeedsports.com)

**XPEED**<sup>®</sup> CRAFTED FOR CHAMPION

## RASH GUARD

**Size Chart**



Size	To fit chest in inches	To fit chest in cm
<b>S</b>	<b>35"-37"</b>	<b>87.5-92.5cm</b>
<b>M</b>	<b>37"-39"</b>	<b>92.5-97.5cm</b>
<b>L</b>	<b>39"-41"</b>	<b>97.5-102.5cm</b>
<b>XL</b>	<b>41"-43"</b>	<b>102.5-107.5cm</b>

To estimate the size you need, please use the following chart to compare your measurement. Please note that the guide is an estimate only and cannot account for individual preferences.

[www.xpeedsports.com](http://www.xpeedsports.com)

**XPEED**<sup>®</sup> CRAFTED FOR CHAMPION

## BELLY PAD

**Size Chart**



Size	Belly pad circumference in cm	Belly pad height in cm	User Height
<b>STD</b>	<b>55 cm</b>	<b>43 cm</b>	<b>147-157 cm</b>

To estimate the size you need, please use the following chart to compare your measurement. Please note that the guide is an estimate only and cannot account for individual preferences.

[www.xpeedsports.com](http://www.xpeedsports.com)

**XPEED**<sup>®</sup> CRAFTED FOR CHAMPION

## SAUNA SUIT

**Size Chart**



Size	To fit chest in inches	To fit chest in cm
<b>S</b>	<b>35"-37"</b>	<b>87.5-92.5cm</b>
<b>M</b>	<b>37"-39"</b>	<b>92.5-97.5cm</b>
<b>L</b>	<b>39"-41"</b>	<b>97.5-102.5cm</b>
<b>XL</b>	<b>41"-43"</b>	<b>102.5-107.5cm</b>

To estimate the size you need, please use the following chart to compare your measurement. Please note that the guide is an estimate only and cannot account for individual preferences.

[www.xpeedsports.com](http://www.xpeedsports.com)

**XPEED**<sup>®</sup> CRAFTED FOR CHAMPION

## BOXING GOWN

**Size Chart**



Size	To fit chest in inches	To fit chest in cm
<b>S</b>	<b>35"-37"</b>	<b>87.5-92.5cm</b>
<b>M</b>	<b>37"-39"</b>	<b>92.5-97.5cm</b>
<b>L</b>	<b>39"-41"</b>	<b>97.5-102.5cm</b>
<b>XL</b>	<b>41"-43"</b>	<b>102.5-107.5cm</b>
<b>XXL</b>	<b>43"-45"</b>	<b>107.5-112.5cm</b>

To estimate the size you need, please use the following chart to compare your measurement. Please note that the guide is an estimate only and cannot account for individual preferences.

[www.xpeedsports.com](http://www.xpeedsports.com)

# SIZE CHART

**XPEED**  
CRAFTED FOR CHAMPION

## MUAY THAI SHORTS

### Size Chart



Size	To fit waist in inches	To fit waist in cm
<b>S</b>	<b>29"-31"</b>	<b>72.5-77.5CM</b>
<b>M</b>	<b>31"-33"</b>	<b>77.5-82.5CM</b>
<b>L</b>	<b>33"-35"</b>	<b>82.5-87.5CM</b>
<b>XL</b>	<b>35"-37"</b>	<b>87.5-92.5CM</b>

To estimate the size you need, please use the following chart to compare your measurement. Please note that the guide is an estimate only and cannot account for individual preferences.

[www.xpeedsports.com](http://www.xpeedsports.com)

**XPEED**  
CRAFTED FOR CHAMPION

## VEST & SHORT

### Size Chart



Size	To fit chest in inches	To fit chest in cm
<b>S</b>	<b>35"-37"</b>	<b>87.5-92.5cm</b>
<b>M</b>	<b>37"-39"</b>	<b>92.5-97.5cm</b>
<b>L</b>	<b>39"-41"</b>	<b>97.5-102.5cm</b>
<b>XL</b>	<b>41"-43"</b>	<b>102.5-107.5cm</b>

To estimate the size you need, please use the following chart to compare your measurement. Please note that the guide is an estimate only and cannot account for individual preferences.

[www.xpeedsports.com](http://www.xpeedsports.com)

**XPEED**  
CRAFTED FOR CHAMPION

## WRESTLING SUIT MEN

### Size Chart



Size	To fit chest in inches	To fit chest in cm
<b>S</b>	<b>35"-37"</b>	<b>87.5-92.5cm</b>
<b>M</b>	<b>37"-39"</b>	<b>92.5-97.5cm</b>
<b>L</b>	<b>39"-41"</b>	<b>97.5-102.5cm</b>
<b>XL</b>	<b>41"-43"</b>	<b>102.5-107.5cm</b>

To estimate the size you need, please use the following chart to compare your measurement. Please note that the guide is an estimate only and cannot account for individual preferences.

[www.xpeedsports.com](http://www.xpeedsports.com)

**XPEED**  
CRAFTED FOR CHAMPION

## VEST & SHORT

### Size Chart



Size	To fit chest in inches	To fit chest in cm
<b>S</b>	<b>35"-37"</b>	<b>87.5-92.5cm</b>
<b>M</b>	<b>37"-39"</b>	<b>92.5-97.5cm</b>
<b>L</b>	<b>39"-41"</b>	<b>97.5-102.5cm</b>
<b>XL</b>	<b>41"-43"</b>	<b>102.5-107.5cm</b>

To estimate the size you need, please use the following chart to compare your measurement. Please note that the guide is an estimate only and cannot account for individual preferences.

[www.xpeedsports.com](http://www.xpeedsports.com)

**XPEED**  
CRAFTED FOR CHAMPION

## VEST & SHORT

### Size Chart

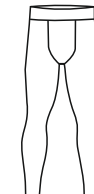

Size	To fit waist in inches	To fit waist in cm
<b>S</b>	<b>29"-31"</b>	<b>72.5-77.5CM</b>
<b>M</b>	<b>31"-33"</b>	<b>77.5-82.5CM</b>
<b>L</b>	<b>33"-35"</b>	<b>82.5-87.5CM</b>
<b>XL</b>	<b>35"-37"</b>	<b>87.5-92.5CM</b>

To estimate the size you need, please use the following chart to compare your measurement. Please note that the guide is an estimate only and cannot account for individual preferences.

[www.xpeedsports.com](http://www.xpeedsports.com)

**XPEED**  
CRAFTED FOR CHAMPION

## WRESTLING SUIT WOMEN

### Size Chart



Size	To fit chest in inches	To fit chest in cm
<b>XS</b>	<b>31"-33"</b>	<b>77.5-82.5cm</b>
<b>S</b>	<b>33"-35"</b>	<b>82.5-87.5cm</b>
<b>M</b>	<b>35"-37"</b>	<b>87.5-92.5cm</b>
<b>L</b>	<b>37"-39"</b>	<b>92.5-97.5cm</b>
<b>XL</b>	<b>39"-41"</b>	<b>97.5-102.5cm</b>

To estimate the size you need, please use the following chart to compare your measurement. Please note that the guide is an estimate only and cannot account for individual preferences.

[www.xpeedsports.com](http://www.xpeedsports.com)

# SIZE CHART

**XPEED**  
CRAFTED FOR CHAMPION

**KARATE CHEST GUARD**

Size Chart

Size	CHEST GUARD WIDTH IN CM (A)	CHEST GUARD HEIGHT IN CM (A)	CHEST SIZE
S/M	85.5 cm	43 cm	84-91cm
L/XL	91 cm	45 cm	91-107cm

To estimate the size you need, please use the following chart to compare your measurement. Please note that the guide is an estimate only and cannot account for individual preferences.

www.xpeedsports.com

**XPEED**  
CRAFTED FOR CHAMPION

**BASIC CHEST GUARD**

Size Chart

Size	CHEST GUARD WIDTH IN CM (A)	CHEST GUARD HEIGHT IN CM (B)	User Height
S	86 cm	38 cm	80-89cm
M	87 cm	41 cm	89-94cm
L	91 cm	46 cm	94-107cm

To estimate the size you need, please use the following chart to compare your measurement. Please note that the guide is an estimate only and cannot account for individual preferences.

www.xpeedsports.com

**XPEED**  
CRAFTED FOR CHAMPION

**ELBOW SLEEVE**

Size Chart

Size	ELBOW SLEEVE WIDTH IN CM (A)	ELBOW SLEEVE HEIGHT IN CM (A)	ELBOW
XS	10.5cm	19cm	21-23cm
S	11.5cm	19.5cm	23-25cm
M	12.5cm	20cm	25-28cm
L	13.5cm	20.5cm	28-31cm
XL	14.5cm	21cm	31-33cm
XXL	15.5cm	21.5cm	33-35cm

To estimate the size you need, please use the following chart to compare your measurement. Please note that the guide is an estimate only and cannot account for individual preferences.

www.xpeedsports.com

**XPEED**  
CRAFTED FOR CHAMPION

**FABRIC SHINGUARD**

Size Chart

Size	FABRIC SHINGUARD WIDTH IN CM (A)	FABRIC SHINGUARD HEIGHT IN CM (B)	User Height (cm)
XS	27cm	14cm	100-120cm
S	28cm	16cm	120-140cm
M	29cm	16.5cm	140-160cm
L	34cm	18.5cm	160-180cm
XL	35cm	19cm	180-200cm
XXL	38cm	21cm	200-220cm

To estimate the size you need, please use the following chart to compare your measurement. Please note that the guide is an estimate only and cannot account for individual preferences.

www.xpeedsports.com

**XPEED**  
CRAFTED FOR CHAMPION

**KNEE SLEEVE**

Size Chart

Size	KNEE SLEEVE WIDTH IN CM (A)	KNEE SLEEVE HEIGHT IN CM (A)	Knee
XS	13cm	24.5cm	28-30cm
S	14cm	24.5cm	30-33cm
M	15cm	24.5cm	33-36cm
L	16cm	25cm	36-39cm
XL	17cm	25cm	39-42cm
XXL	18cm	25cm	42-45cm

To estimate the size you need, please use the following chart to compare your measurement. Please note that the guide is an estimate only and cannot account for individual preferences.

www.xpeedsports.com

**XPEED**  
CRAFTED FOR CHAMPION

**GRAPPLING SHINGUARD**

Size Chart

Size	GRAPPLING SHINGUARD WIDTH IN CM (A)	GRAPPLING SHINGUARD FOOT HEIGHT IN CM (B)	User Height (cm)
S/M	36 cm	16 cm	138-178cm
L/XL	38 cm	18 cm	178-198cm

To estimate the size you need, please use the following chart to compare your measurement. Please note that the guide is an estimate only and cannot account for individual preferences.

www.xpeedsports.com

# SIZE CHART

**XPEED**  
CRAFTED FOR CHAMPION

**KNEE GUARD**

**Size Chart**

Size	Knee guard Length in cm (A)	Knee guard Width in cm (B)	Knee Circumference
S/M	20cm	13cm	24-26cm
L/XL	24cm	14cm	26-28cm

To estimate the size you need, please use the following chart to compare your measurement. Please note that the guide is an estimate only and cannot account for individual preferences.

www.xpeedsports.com

**XPEED**  
CRAFTED FOR CHAMPION

**TAEKWONDO FOOTPROTECTOR**

**Size Chart**

Size	TAEKWONDO FOOT PROTECTOR WIDTH IN CM (A)	TAEKWONDO FOOT PROTECTOR HEIGHT IN CM (B)	User Size (cm)
S	24.5cm	12cm	22-24cm
M	25.5cm	12.5cm	24-26cm
L	26.5cm	13cm	26-28cm
XL	27.5cm	13.5cm	28-30cm

To estimate the size you need, please use the following chart to compare your measurement. Please note that the guide is an estimate only and cannot account for individual preferences.

www.xpeedsports.com

**XPEED**  
CRAFTED FOR CHAMPION

**ELBOW GUARD**

**Size Chart**

Size	Elbow guard Length in cm (A)	Elbow guard Width in cm (B)	Elbowee Circumference
XS	21cm	13cm	20-22cm
S/M	24cm	13cm	22-25cm
L/XL	27cm	14cm	25-28cm

To estimate the size you need, please use the following chart to compare your measurement. Please note that the guide is an estimate only and cannot account for individual preferences.

www.xpeedsports.com

**XPEED**  
CRAFTED FOR CHAMPION

**MARTIAL ARTS DRESSES**

**Size Chart**

	HEIGHT (CM)	WEIGHT (Kgs.)	SIZE
a. Karate	90-100	15-20	100
	100-110	18-27	110
	110-120	25-32	120
	120-130	30-40	130
	130-140	38-50	140
b. Taekwondo DoBok	140-150	48-65	150
	150-160	63-77	160
	160-170	75-90	170
C. Judo Gis	170-180	86-100	180
	180-190	95-118	190
	190-200	115-130	200

To estimate the size you need, please use the following chart to compare your measurement. Please note that the guide is an estimate only and cannot account for individual preferences.

www.xpeedsports.com



MADE FOR CHAMPIONS

**XPEED®**  
CRAFTED FOR CHAMPIONS

**COMBAT  
MODE**

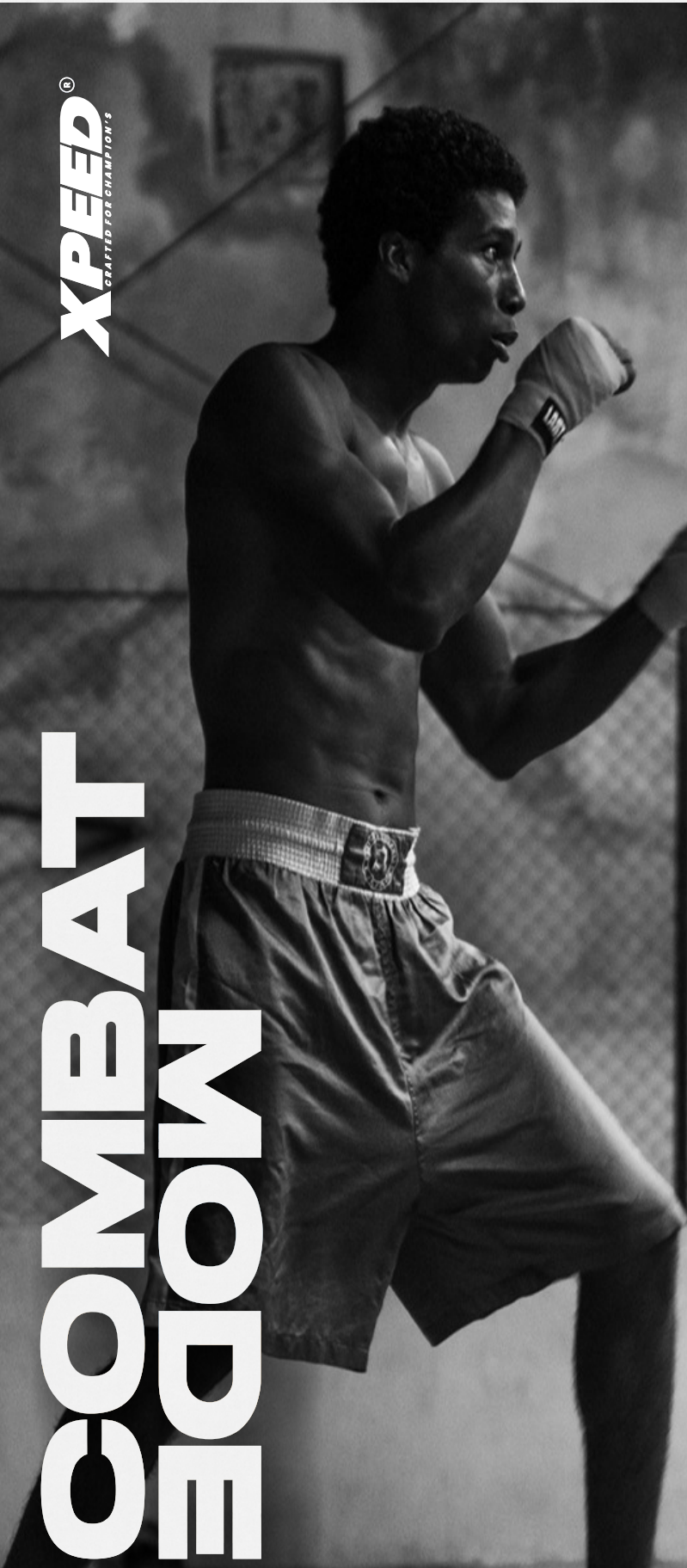



# XPEED SPORTS

(Unit of Krishna Sports Industries)

S-10, INDUSTRIAL AREA,  
JALANDHAR 144 004

GSTIN : 03AAAFX2660B1ZR



Visit Us : [www.xpeedsports.com](http://www.xpeedsports.com)